

dr. Kristijan Musek Lešnik

dr. Petra Lešnik Musek

SLEDENJE LIKOM: KROGI

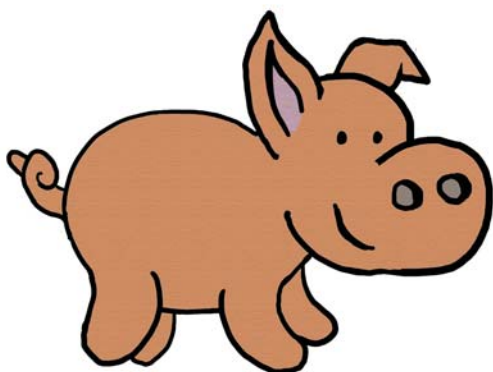

SLEDI
PIKČASTIM
ČRTAM IN RIŠI
KROGE.

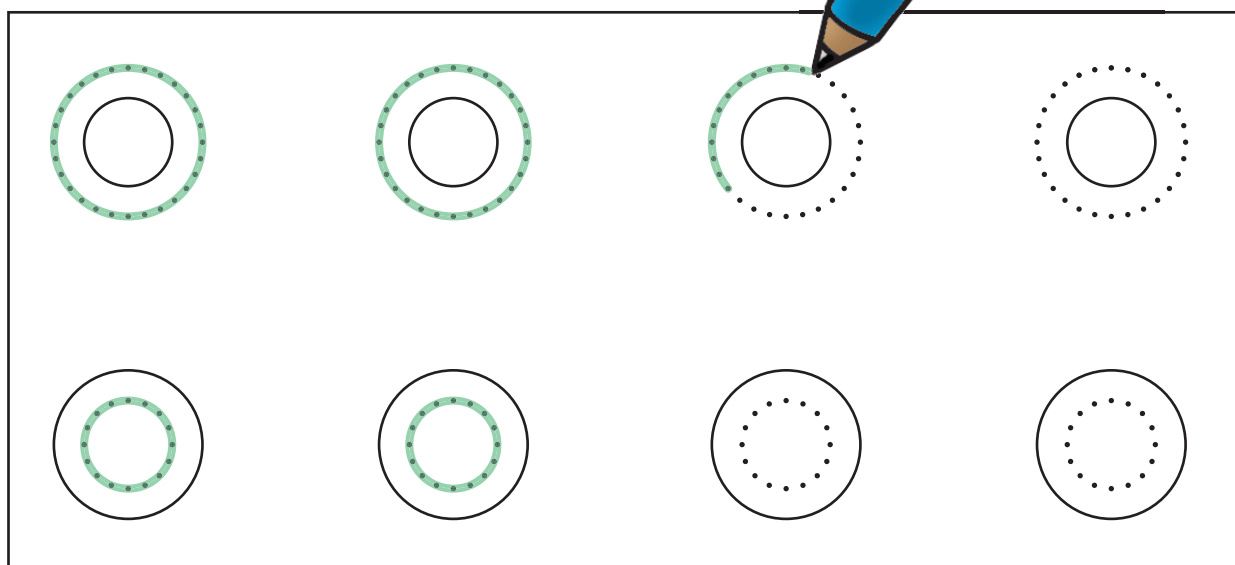
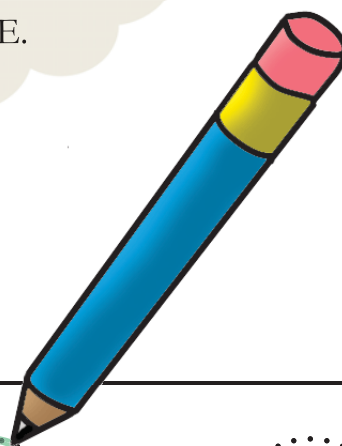

SLEDENJE LIKOM: KROGI

dr. Kristijan Musek Lešnik

dr. Petra Lešnik Musek

Naslov delovnega zvezka: SLEDENJE LIKOM: KROGI

Zbirka: Program za razvijanje grafomotoričnih, finomotoričnih in pisalnih spretnosti: Sledenje likom

Avtorja in nosilca avtorskih pravic: dr. Kristijan Musek Lešnik, dr. Petra Lešnik Musek

Prva izdaja

Leto izida: 2013

Leto izdelave: 2014

Oblika natisa: delovni zvezek v elektronski obliki

Format delovnega zvezka: A4

Število strani: 73

Založba:

IPSOS dr. Kristijan Musek Lešnik s.p.

Požarnice 26d, 1351 Brezovica pri Ljubljani

www.ipsos.si

www.abced.org

CIP - Kataložni zapis o publikaciji

Narodna in univerzitetna knjižnica, Ljubljana

159.946.4-053.5(076.034.2)

MUSEK Lešnik, Kristijan

Sledenje likom. 1, Krogi [Elektronski vir] / Kristijan Musek Lešnik, Petra Lešnik Musek. - 1. izd. - El. knjiga. - Brezovica pri Ljubljani : IPSOS, 2013. - (Zbirka Program za razvijanje grafomotoričnih, finomotoričnih in pisalnih spretnosti. Sledenje likom)

ISBN 978-961-6671-66-8 (pdf)

1. Lešnik Musek, Petra

267225088

V zadnjih letih vse več raziskav opozarja, kako pomembno vlogo v otrokovem razvoju igra razvoj drobno gibalnih spretnosti.

Drobno gibalne in vidno prostorske spretnosti so pri predšolskih in šolskih otrocih povezane s splošnimi in specifičnimi kognitivnimi zmožnostmi kot so kratkoročni spomin, vizualno procesiranje, dolgoročni spomin in priklic, fluidno mišljenje in kristalizirana inteligentnost, pa tudi s poznejšimi dosežki ter ucnim uspehom, ali neuspehom.

Nekatere raziskave kažejo, da mnogi učenci prav zaradi slabše razvitih drobno gibalnih spretnosti dosegajo slabše rezultate, kot bi jih pričakovali glede na njihove intelektualne zmožnosti.

Druge raziskave opozarjajo, da ustrezno strukturirani programi v predšolski in v šolski dobi vodijo k izboljšanju vidno prostorskih in drobno gibalnih spretnosti ter posledično k boljšim dosežkom.

Zato je še kako pomembno, da pri predšolskih in šolskih otrocih sistematično spodbujamo in krepimo razvoj drobno gibalnih spretnosti in grafomotorike.

KAZALO

POMEN URJENJA GRAFOMOTORIKE	5
GRAFOMOTORIČNE VAJE ZA OTROKE	7
SLEDENJE	8
DELOVNI LISTI	9
VIRI	72

POMEN URJENJA DROBNO GIBALNIH SPRETNOSTI IN GRAFOMOTORIKE

Drobno gibalne in vidno prostorske spretnosti so pri predšolskih in šolskih otrocih povezane z različnimi kognitivnimi zmožnostmi (kratkoročni spomin, vizualno procesiranje, dolgoročni spomin in priklic, fluidno mišljenje, kristalizirana inteligentnost, ipd.), pa tudi z njihovimi poznejšimi dosežki ter ucnim uspehom, ali neuspehom.

“Eno je gotovo – pisani jezik otrok se razvija tako, da se pomika od risanja stvari k risanju besed. Vsa skrivnost poučevanja pisanega jezika je pripraviti in organizirati ta naravni prehod na ustrezen način.

Lev S. Vygotsky, esej “*The Prehistory of Writing*”, 1930 v knjigi *The Mind in Society*, 1978, po Sheridan, 2002

»Čeprav se zdi ponavljajoče mehanično urjenje, ki spremlja vaje ročnega pisanja, zastarelo, tovrstna telesna dejavnost pomaga učencem uspeti. Te dejavnosti spodbujajo aktivnost možgan, vodijo k bolj tekočemu jeziku in pripomorejo v razvoju pomembnega znanja.«

Frank Wilson, “*The Hand: How Its Use Shapes the Brain, Language and Human Culture*”, 1999)

Kaj so drobnogibalne spretnosti?

Drobno gibalne (*finomotorične*) spretnosti so priučene spretnosti, ki vključujejo gibe manjših delov telesa (rok, zapestij, prstov, pa tudi drugih manjših sklopov mišic) v sodelovanju z vidom. Razvijajo se od zgodnjega otroštva naprej in otrokom omogočajo vse bolj natančna dejanja (*na primer rokovanje z jedilnim priborom, natančen pincetni prijem, popravilo drobnih delov ure, ipd.*). Med ključne drobnogibalne spretnosti sodijo grafomotorične spretnosti.

Zakaj so drobnogibalne spretnosti tako pomembne?

V zadnjih letih vse več raziskav opozarja, kako pomembno vlogo v otrokovem razvoju igra razvoj drobnogibalnih spretnosti. Drobno gibalne in vidno prostorske spretnosti so pri predšolskih in šolskih otrocih povezane s splošnimi in specifičnimi kognitivnimi zmožnostmi kot so kratkoročni spomin, vizualno procesiranje, dolgoročni spomin in priklic, fluidno mišljenje in kristalizirana inteligentnost (*Davis, Pitchford in Limback, 2011*), pa tudi s poznejšimi dosežki ter ucnim uspehom, ali neuspehom pri matematiki in pri drugih predmetih (*Beery in Beery, 2004; Cameron in sod., 2012; Carlson, Rowe in Curby, 2013; Curby in Carlson, 2014; Cirelli Coppede, in sod. 2012; Dineheart in Manfra, 2013; Grissmer in sod., 2010; Gunderson in sod., 2012; Lahav, Apter in Ratzon, 2013; Luo in sod., 2007; Morales in sod., 2011; Murrach, Chen in Cameron, 2013; Pagani in sod., 2010, 2011, 2012; Pereira, Araujo in Bracciali, 2011, Pontart in sod., 2013; Roebbers in sod., 2013; Sortor in Kulp, 2003; Stoeger, Suggate in Ziegler, 2013; Stoeger in Ziegler, 2010*). Mnogi učenci prav zaradi slabše razvitih drobnogibalnih spretnosti dosegajo slabše rezultate, kot bi jih pričakovali glede na njihove intelektualne zmožnosti (*Stoeger, Ziegler in Martzog, 2008; Stoeger, Suggate in Ziegler, 2013; Stoeger in Ziegler, 2013*).

Pomembno je vedeti, da lahko razvoj drobnogibalnih spretnosti pri predšolskih in šolskih otrocih sistematično spodbujamo in krepimo. Raziskave potrjujejo, da ustrezno strukturirani programi v predšolski in v šolski dobi vodijo k izboljšanju vidno prostorskih in drobnogibalnih spretnosti ter posledično k boljšim dosežkom (*Eisenstat, 2006; Fahimi in sod., 2013; Brown, 2010; Grissmer in sod., 2013, po Sparks, 2013; Hamm in Harper, 2014; St. John, 2013; Stewart, Rule in Giordano, 2007*).

Kaj so grafomotorične spretnosti?

Grafomotorične spretnosti so kombinacija spoznavnih (*kognitivnih*), zaznavnih (*perceptivnih*) in drobnogibalnih (*finomotoričnih*) spretnosti, ki otroku omogočajo, da na papir, ali na drugo podlago prenese podobe, ki si jih zamisli. Grafomotorične spretnosti zahtevajo dobro sodelovanje med vidno zaznavnimi in mišičnimi sistemi. Razvijajo se vzporedno z zorenjem različnih spoznavnih, zaznavnih in gibalnih spretnosti. Njihov postopni razvoj se dogaja ob spontanih izkušnjah, naj pa lahko vplivamo tudi s pomočjo usmerjene vadbe.

Razvijajoče se grafomotorične spretnosti otrokom omogočajo napredovanje od prvih poskusov beleženja pomembnih idej ali podob iz okolja proti zapletenejšemu izražanju in trajnemu beleženju simbolov in misli. Ena od najbolj kompleksnih spoznavno-zaznavno-gibalnih spretnosti je pisanje. Zato ni naključje, da so raziskovalci v večini študij, ki so v zadnjih letih opozorile na pomen drobnogibalnih spretnosti za kognitivni razvoj in učne dosežke, raven drobnogibalnih spretnosti pri otrocih med drugim ugotavljali prav s pomočjo grafomotoričnih nalog (prim.: *Cameron in sod., 2012; Davis, Pitchford in Limback, 2011; Dineheart in Manfra, 2013; Grissmer in sod., 2010; Luo in sod., 2007; Piek, Hands in Licari, 2012; Pontart in sod., 2013; Stoeger, Suggate in Ziegler, 2013*).

Zakaj grafomotorične vaje, če pisanje z roko izumira?

Razvoj in širjenje informacijske tehnologije ob koncu 20. in na začetku 21. stoletja globoko vpliva na izobraževalne procese v šolah. Ena od nenačrtovanih posledic tega razvoja je postopno spontano opuščanje "zastarelih" praks. Tudi popuščanje pri učenju in utrjevanju pisanja in s pisanjem povezanih spretnosti, je velikokrat pospremljeno z ugotovitvijo, da bodo današnji otroci v prihodnosti veliko več tipkali na tipkovnice ali pritiskali znake na zaslonih različnih komunikacijskih naprav, kot pa pisali.

Danes večina pisanih besedil ne nastaja več s pisanjem na papir, pač pa s pomočjo digitalnih pripomočkov, od računalnikov do pametnih telefonov in tabličnih računalnikov. Učenje pisanja, ki je bilo več stoletij en od temeljev izobraževanja otrok, se lahko zdi v času razcveta komunikacijske tehnologije, ko otroci pišejo s tipkovnicami, ali preko tabličnih računalnikov, zastarelo in nepotrebno. Vse več otrok zapušča osnovno šolo, ne da bi resnično osvojili in obvladali pisanje s pisanimi črkami. Vedno več srednješolcev in študentov pisne izdelke pripravlja z računalnikom, če že morajo pisati, pa pišejo z velikimi tiskanimi črkami. (Raziskava več kot 1.5 milijona esejev, ki so jih v letu 2005 pisali 16 in 17 letni ameriški dijaki, je na primer pokazala, da jih je le 15 odstotkov pisalo s pisanimi črkami; vir *CollegeBoard, 2006.*)

Popuščanje pri učenju in utrjevanju predpisalnih spretnosti in pisanja se zdi logična posledica ugotovitve, da današnjih otrok nima smisla obremenjevati z izumirajočo spretnostjo, ki jim v življenju ne bo pomembno koristila. Ta ugotovitev sloni na predpostavki, da se da pisanje z roko preprosto nadomestiti z drugimi oblikami pisnega izražanja, od tipkanja do uporabe pametnih tabličnih pripomočkov. Vendar ima ta predpostavka resno in globoko težavo: **JE NAPAČNA in NEVARNA!**



Zaradi takšnih poenostavljenih in napačnih predpostavk se v mnogih šolah in šolskih sistemih vse manj časa in pozornosti namenja urjenju in utrjevanju drobno motoričnih, grafomotoričnih, predpisalnih in pisalnih spretnosti. Otroci, katerih starši so v šolah popisali kilometre vrstic v zvezke, obkrožajo in podčrtujejo besedila v delovnih zvezkih, tipkajo besedila prek tipkovnic in pomikajo prste ter izbirajo znake na zaslonih tabličnih računalnikov in pametnih telefonov. Dobra plat tega je, da se učijo uporabljati komunikacijska orodja in tehnologijo. Slaba pa, da veliko manj urijo grafomotoriko in pisanje z roko.

Uveljavljeni nevrolog F. R. Wilson poudarja, da je prav edinstvena struktura človeške roke in njena evolucija v sodelovanju z možgani omogočila človeški vrsti postati najbolj inteligentno bitje na Zemlji. V knjigi *"The Hand: How its Use Shapes the Brain, Language, And Human Culture"* (2001) opozarja, da je roka prav tako pomembna kot so pomembni naši možgani in da je neločljivo povezana z učenjem. Zato poudarja, da vsako izobraževanje, ki se osredotoča zgolj na um, vodi v osiromašenje in da bo v šolskih okoljih, kjer bo upadal poudarek na dejavnostih, ki vključujejo gibanje rok in telesa, prejkoslej tudi drugo znanje slabše obdelano in nezadostno naučeno. Spoznanje, da je roka organ, ki izdatno sodeluje pri spodbujanju umske dejavnosti in prevajanju misli v jezik, potrjujejo tudi sodobne raziskave, ki vključujejo slikanje možgan s funkcionalno magnetno resonanco (*Berninger, 2012.*)



Roka je prav tako pomembna kot so pomembni naši možgani.

GRAFOMOTORIČNE VAJE ZA OTROKE

Kaj so grafomotorične vaje?

Grafomotorične vaje so različne dejavnosti tipa pisalo-papir, ki so namenjene spodbujanju drobnogibalnih spretnosti roke, izboljšanju koordinacije oko – roka, spodbujanju pozornosti in natančnosti. Tovrstne vaje ne prispevajo le k utrjevanju spretnosti, ki jih potrebujemo za pisanje, pač pa spodbujajo razvoj drobnogibalnih spretnosti, ki jih potrebujemo tudi pri številnih drugih dejavnostih, kjer pridejo do izraza drobni gibi in občutljiva koordinacija med očmi in rokami.

Raziskave (*Golos in sod., 2011; Kambas in sod., 2010; Keller, 2001; Ratzon, Efraim in Bart, 2007; Vinter in Chartrel, 2010*) opozarjajo, da dejavnosti, ki spodbujajo senzorno integracijo in prispevajo k spodbujanju in vizualno-motoričnega nadzora, vodijo k utrjevanju grafomotoričnih spretnosti in pisanja ter pozitivno vplivajo na učenje pisanja. To še posebno velja za vizualno motorične vaje oziroma urjenje (*Kambas in sod., 2010; Sudsawad in sod., 2002; Vinter in Chartrel, 2010*). Vaje v okviru programa ABC.ED so namenjene takšnemu vizualno-motoričnemu urjenju in utrjevanju predpisalnih in pisalnih spretnosti učencev. Načrtovane so tako, da spodbujajo različne vidike razvoja grafomotorike in različne spretnosti, ki postopoma prispevajo k razvoju drobno gibalnih spretnosti, grafomotorike in pisanja.

Dejavnosti, ki spodbujajo senzorno integracijo in prispevajo k spodbujanju in vizualno-motoričnega nadzora, vodijo k utrjevanju grafomotoričnih spretnosti in pisanja ter dolgoročno pozitivno vplivajo na učenje pisanja.



Grafomotorične vaje in razvoj vizualno motorične integracije

Vizualno motorična integracija je koordinacija vidnih zaznav z gibi telesa, še posebno z gibi roke in prstov (Beery in Beery, 2004). Najbolj intenzivno se razvija v otroških letih, ko se morajo otroci naučiti koordinirati gibe telesa z okoljem in s predmeti okrog njih. Čeprav je vizualno motorična integracija ena od temeljnih zmožnosti za uspešno ukvarjanje tako s telesnimi aktivnostmi in športom kot tudi za umetniško izražanje (od slikanja do kiparjenja in drugih vrst oblikovanja različnih snovi), jo velikokrat najbolj povezujemo prav s pisanjem. Vendar se njen domet tu nikakor ne zaključuje: tako kot je pomembna za pisanje z roko, je vizualno motorična integracija nujen pogoj za široko paleto raznovrstnih človeških opravil, tudi za uspešno rokovanje s sodobnimi komunikacijskimi orodji, od računalnika do tabličnih računalnikov in pametnih telefonov. Sodobne raziskave opozarjajo tudi, da se učinkovita vizualno motorična integracija povezuje še z mnogimi drugimi pomembnimi dejavniki uspešnega življenja; pri otrocih se na primer povezuje z večjo uspešnostjo pri branju, računanju, matematiki in drugih dejavnostih (*Beery in Beery, 2004; Lahav, Apter in Ratzon, 2013; Pereira, Araujo in Bracciali, 2011, Sortor in Kulp, 2003*).

Grafomotorične vaje niso namenjene le otrokom s težavami pri pisanju

V preteklosti so bili programi grafomotoričnih vaj namenjeni predvsem otrokom, ki so imeli težave pri učenju pisanja. Vaje, kakršne so na primer zajete v programu Write from the start (*Teodorescu in Addy, 1996*), so bile namenjene podpori otrokom s težavami na področju grafomotorike. Podobne grafomotorične vaje je v slovenskem prostoru pred 40 leti pripravil Borut Šali.

Vaje v okviru programa ABC.ED so namenjene vsem otrokom. Načrtovane so tako, da spodbujajo različne vidike razvoja senzomotorike, grafomotorike in drugih spretnosti, ki prispevajo k razvoju predpisalnih in predpisalnih spretnosti ter k razvoju pisanja in drugih drobno gibalnih spretnosti. V vsakem delovnem zvezku je večje število različnih vaj, ki jih lahko izbiramo glede na trenutne spretnosti in izkušnje različnih otrok za optimalen učinek.

Vaje v okviru programa ABC.ED spodbujajo različne vidike razvoja senzomotorike in grafomotorike in različne spretnosti, ki prispevajo k razvoju pisanja in drugih drobno-gibalnih spretnosti.



SLEDENJE

O sledenju

Sledenje je pomembna aktivnost pri spodbujanju koordinacije oko - roka. Ko s svinčnikom ali drugim risalom sledi narisani predlogi, otrok s pogledom sproti primerja napredujočo risbo z osnovno predlogo. Pri tem se utrjuje nadzor nad drobnimi gibi roke s katerimi otrok nadzira gibanje pisala in se krepi vizualno motorična integracija.

Naloge sledenja so pomembne za pridobivanje spretnosti, ki igrajo pomembno vlogo pri razvoju pisanja, risanja in drugih drobno gibalnih spretnosti.

Med risanjem oziroma sledenjem predlogam naj otrok ne spreminja položaja lista in naj ga ne obrača. Če je le mogoče, naj poskusi risati posamezen lik v eni potezi, brez ustavljanja ali prestavljanja pisala.

Delovni listi in dejavnosti v tem delovnem zvezku

Naloge v tem delovnem zvezku so načrtovane tako, da otrok s sledenjem različno velikim krogom utrjuje vizualno motorično integracijo in grafomotorične spretnosti, predvsem drobne krožne gibe. Predloženi krogi so narisani z nizom pikic ali črtic, ki jim mora otrok slediti med risanjem. Pri nekaterih delovnih listih je pikčastemu krogu, ki mu sledi otrok, dodan pomožni zunanji ali notranji krog, ki je otroku v pomoč pri risanju. Težavnost nalog v delovnem zvezku se stopnjuje z manjšanjem krogov, ki jim otroci sledijo pri risanju.

Primer: večji krog z notranjim pomožnim krogom

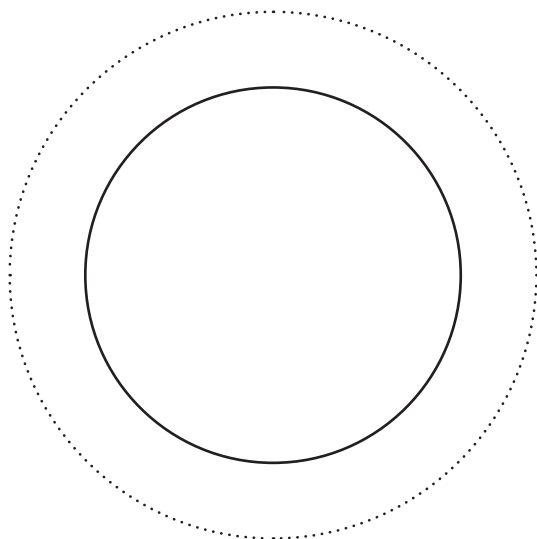

Primer: srednji krog, brez pomožnega kroga

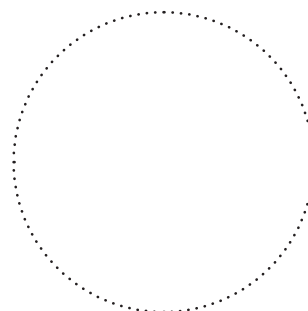

Primer: manjši krog z zunanjim pomožnim krogom

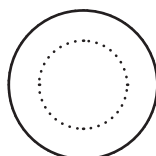

DELOVNI LISTI

Sledi pikčasti črti in nariši krog.

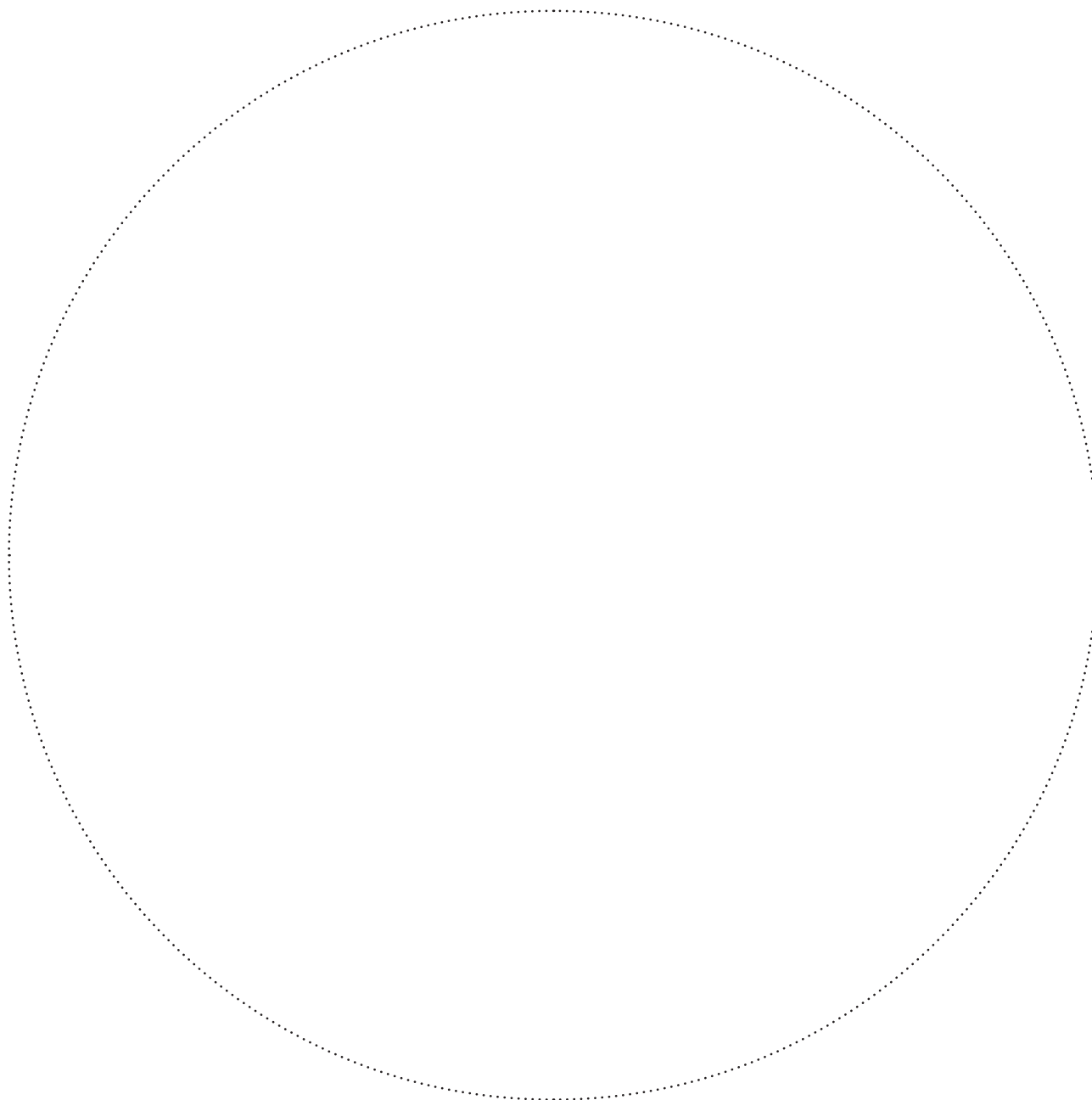
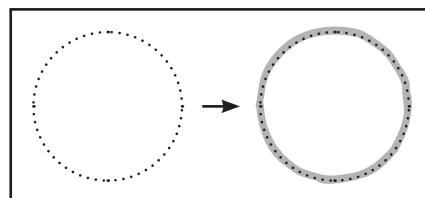

Sledi pikčasti črti in nariši krog.

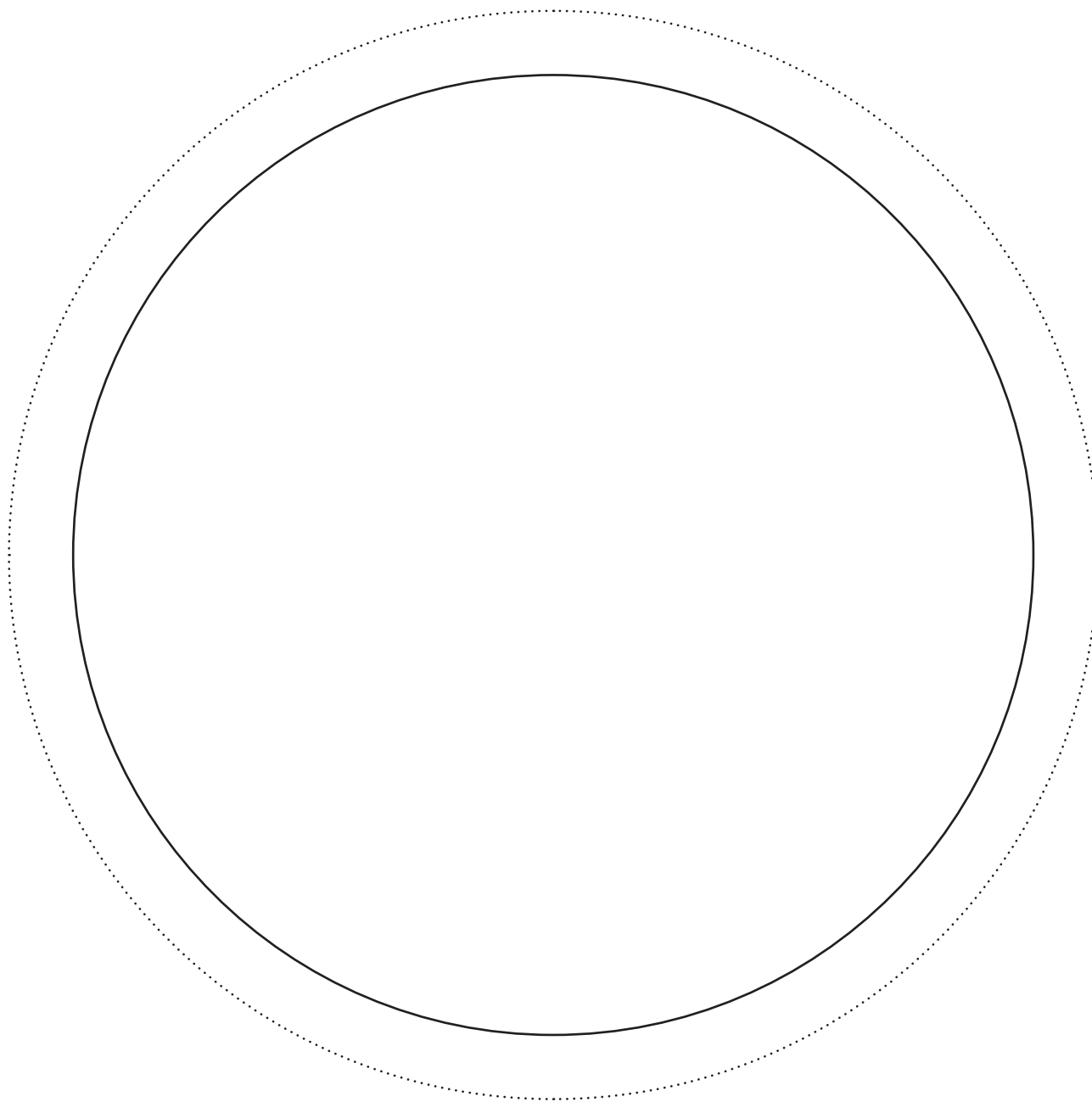
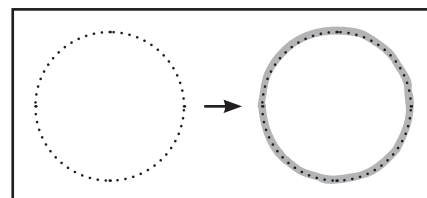

Sledi pikčasti črti in nariši krog.

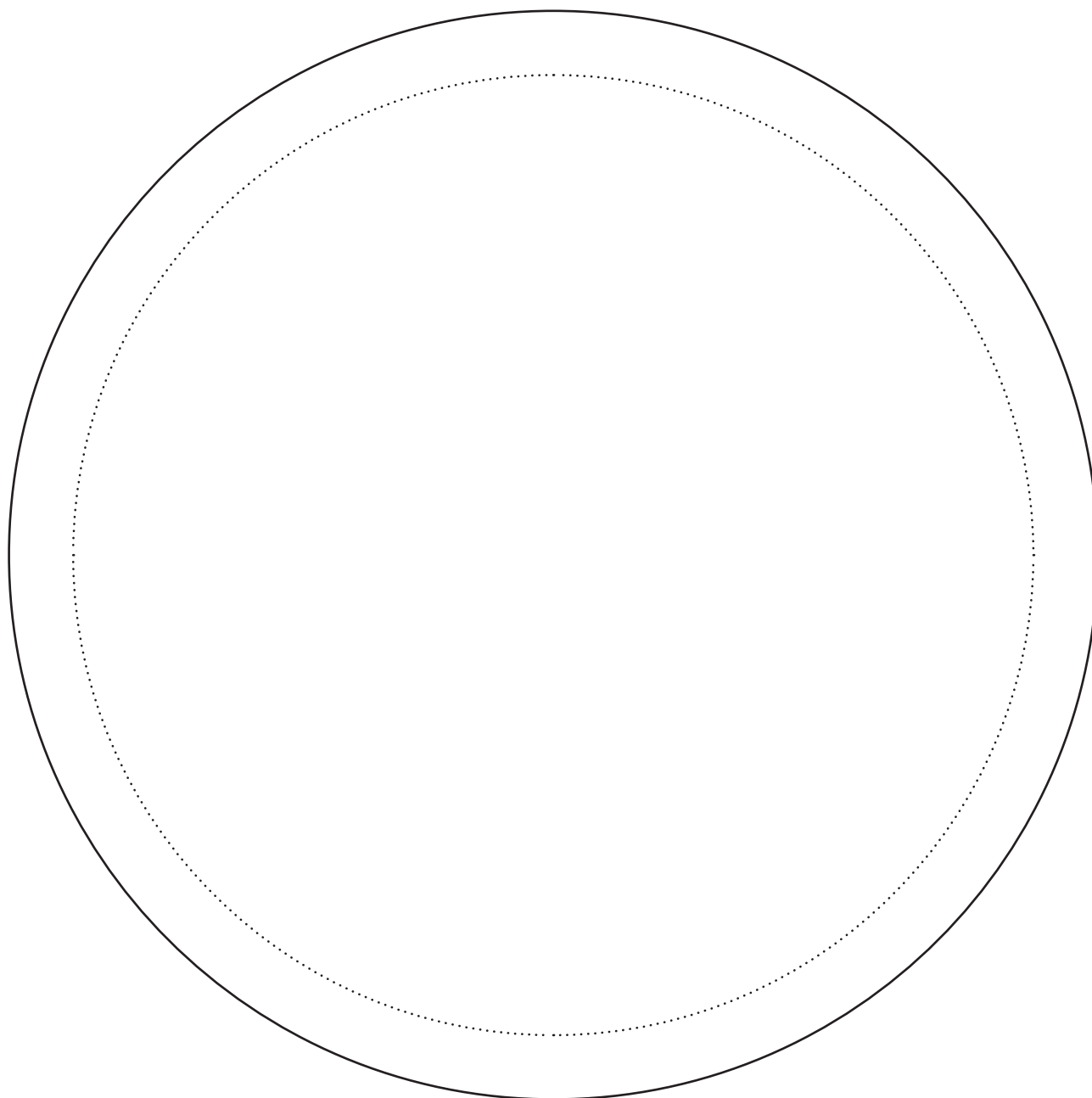
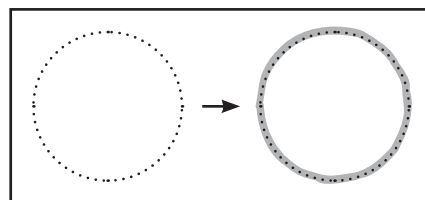

Sledi pikčastim črtam in riši kroge.

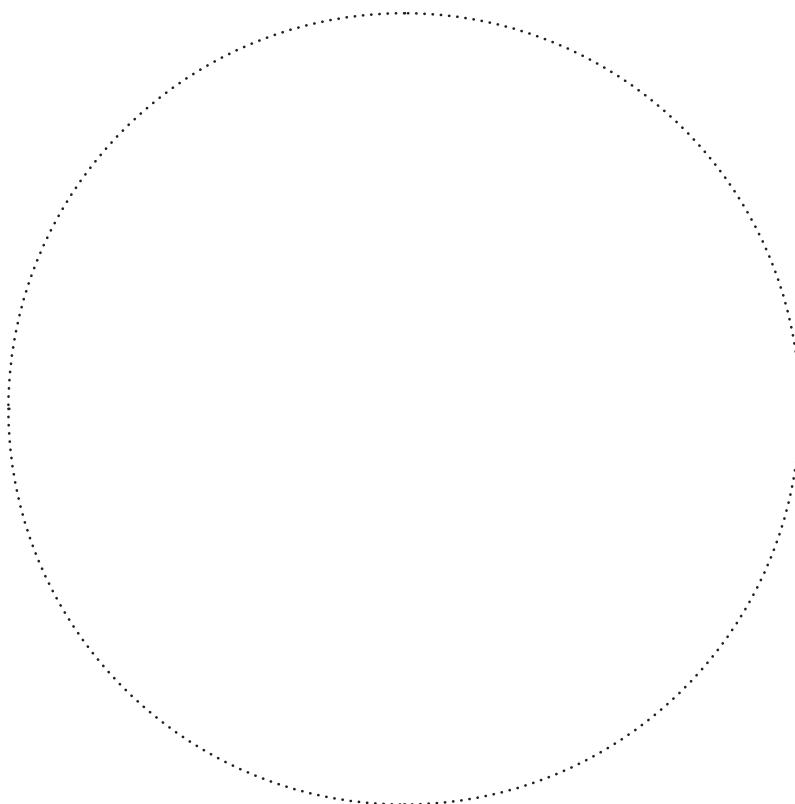
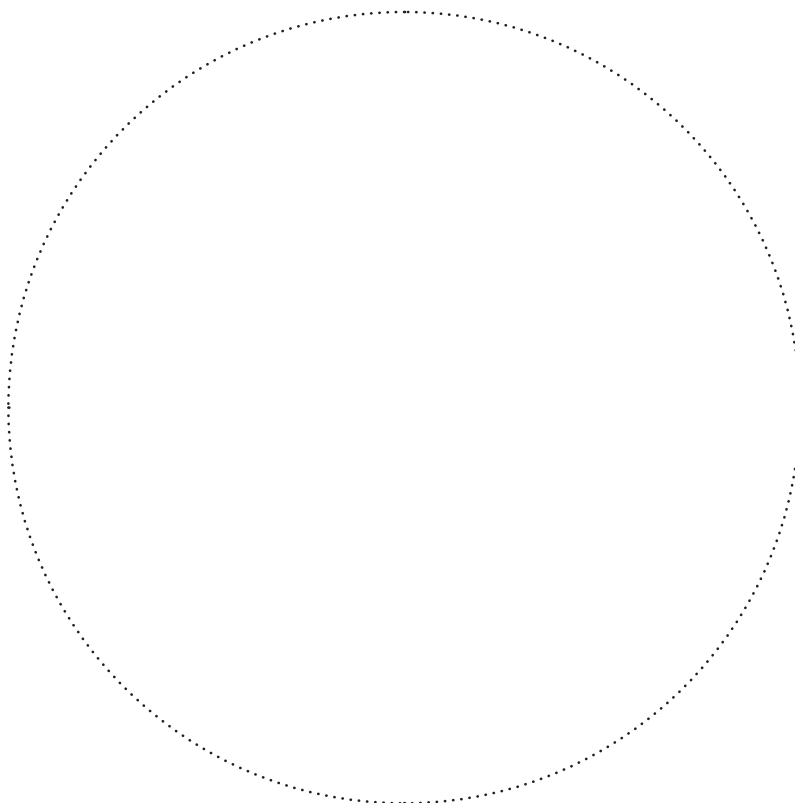
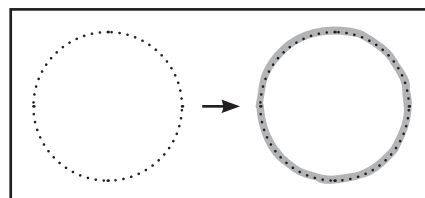

Sledi pikčastim črtam in riši kroge.

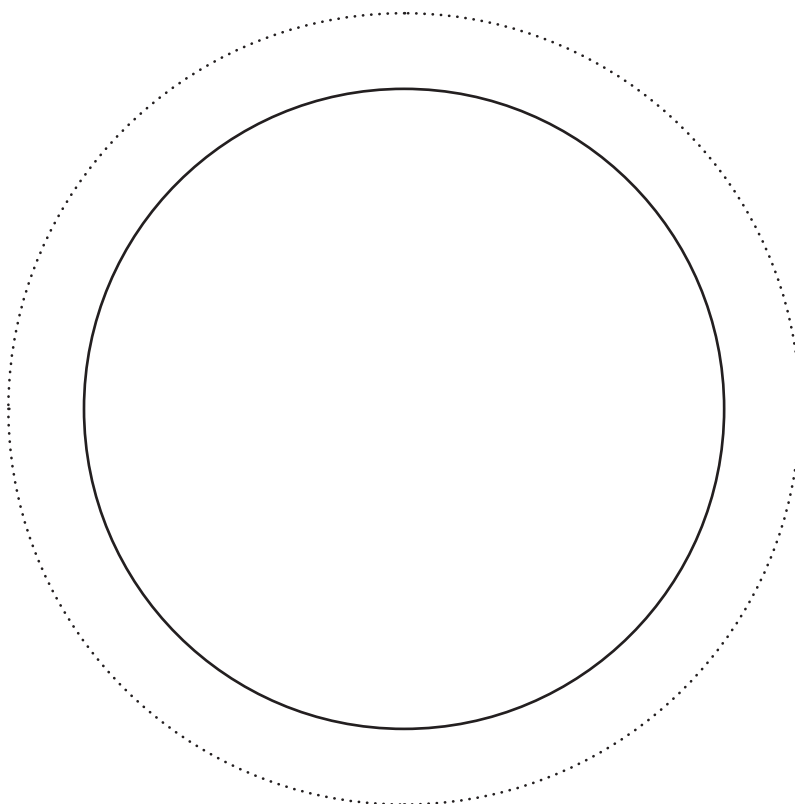
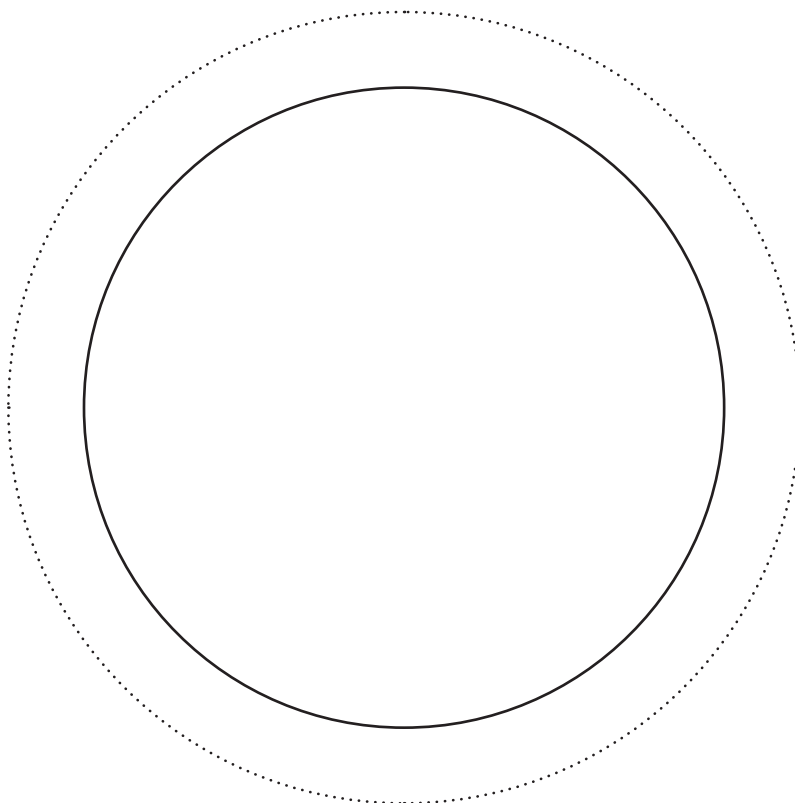
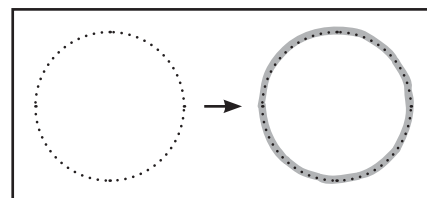

Sledi pikčastim črtam in riši kroge.

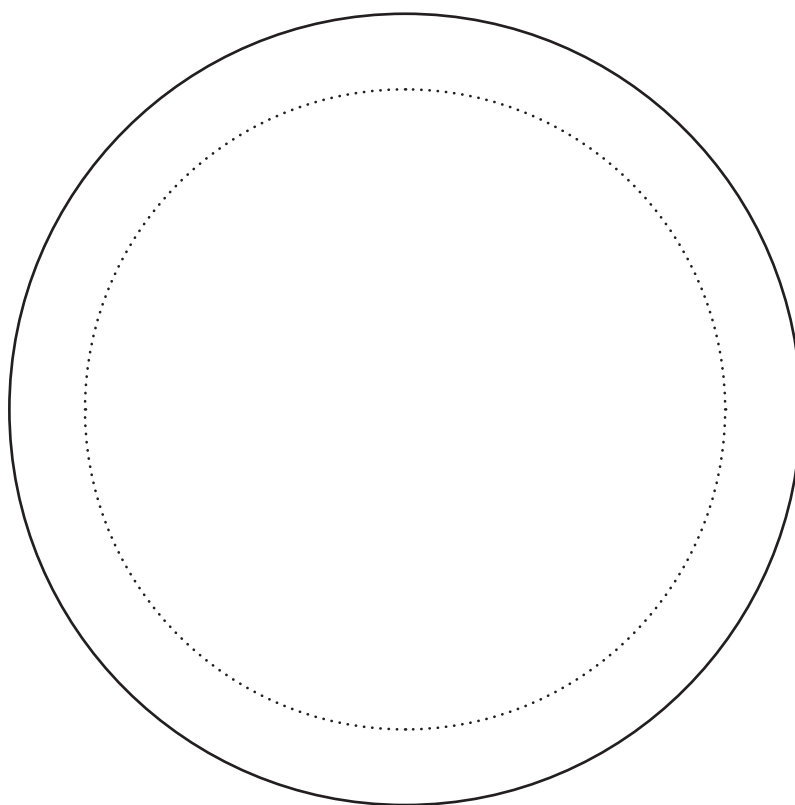
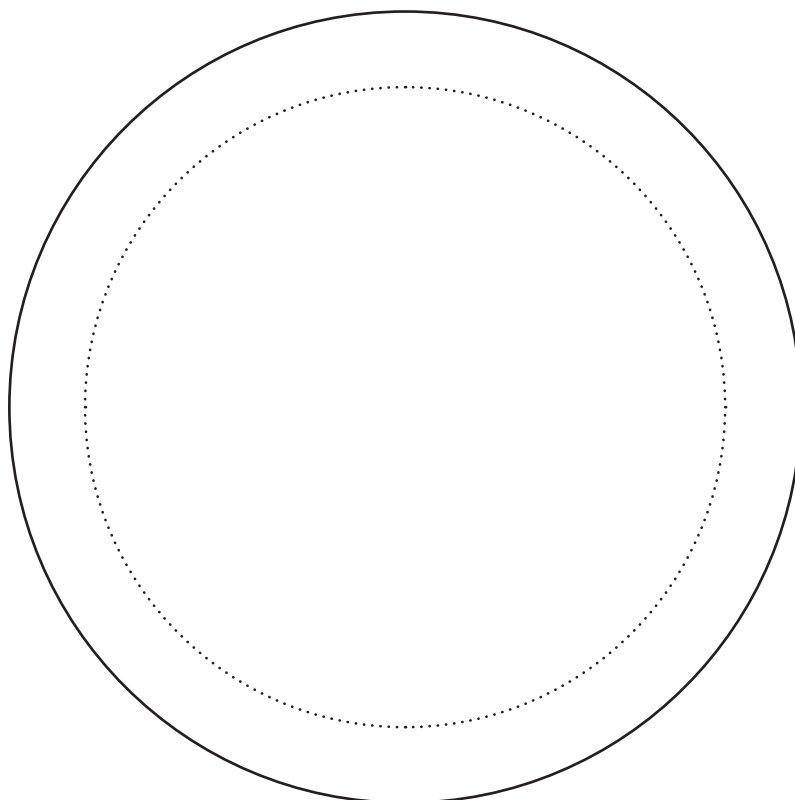
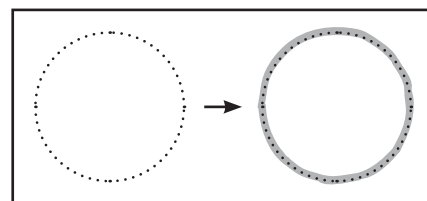

Sledi pikčastim črtam in riši kroge.

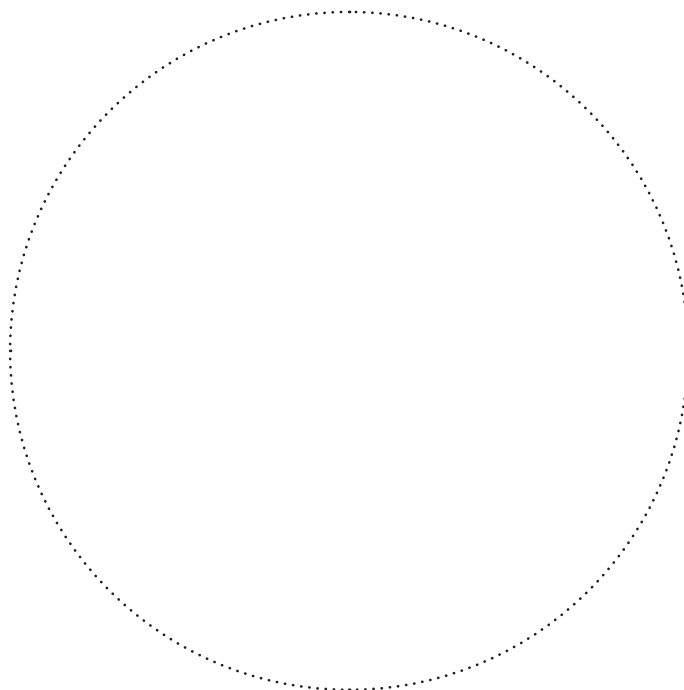
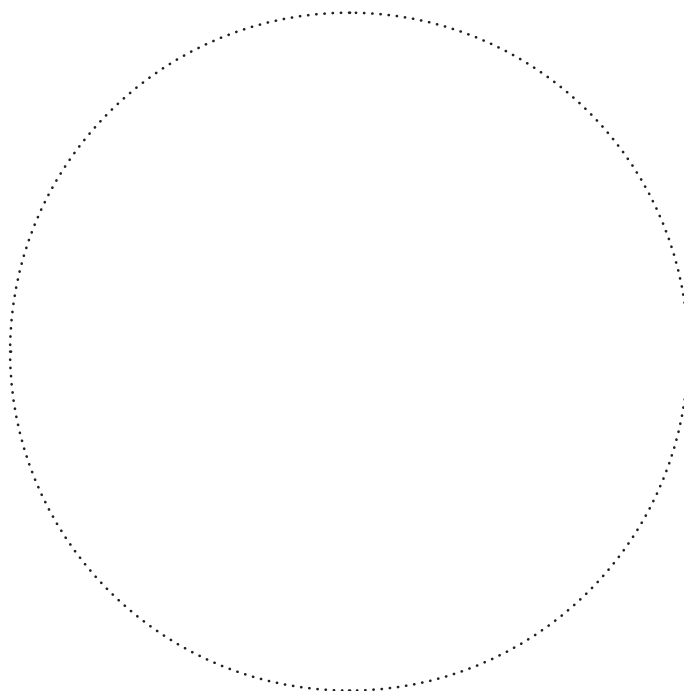
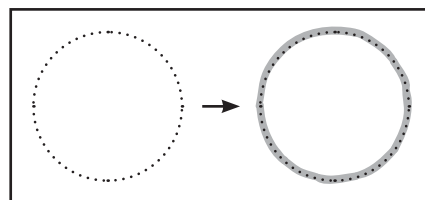

Sledi pikčastim črtam in riši kroge.

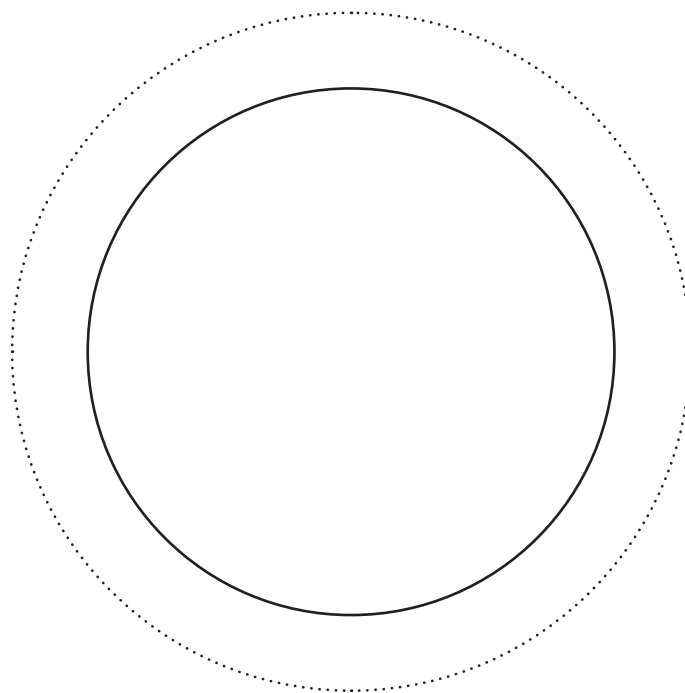
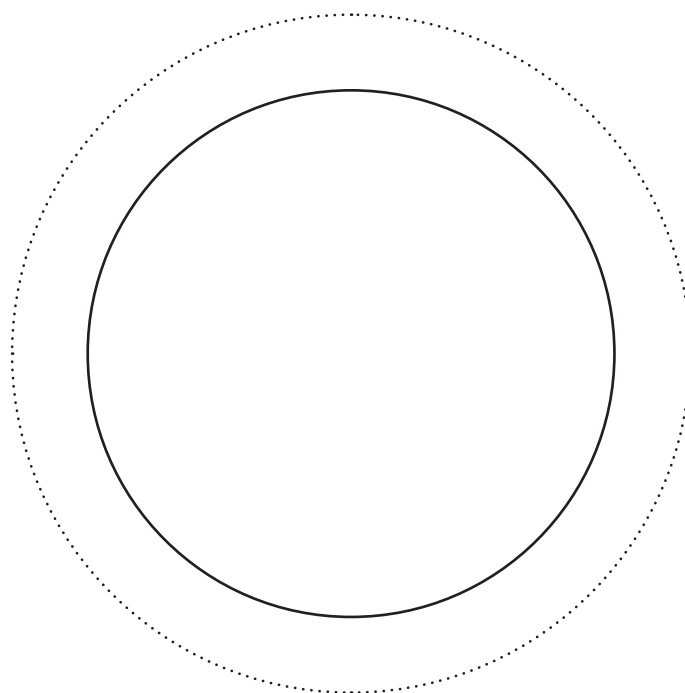
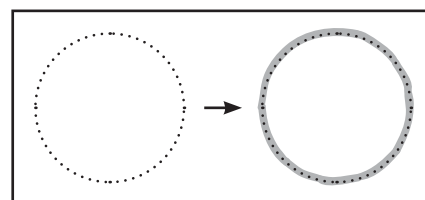

Sledi pikčastim črtam in riši kroge.

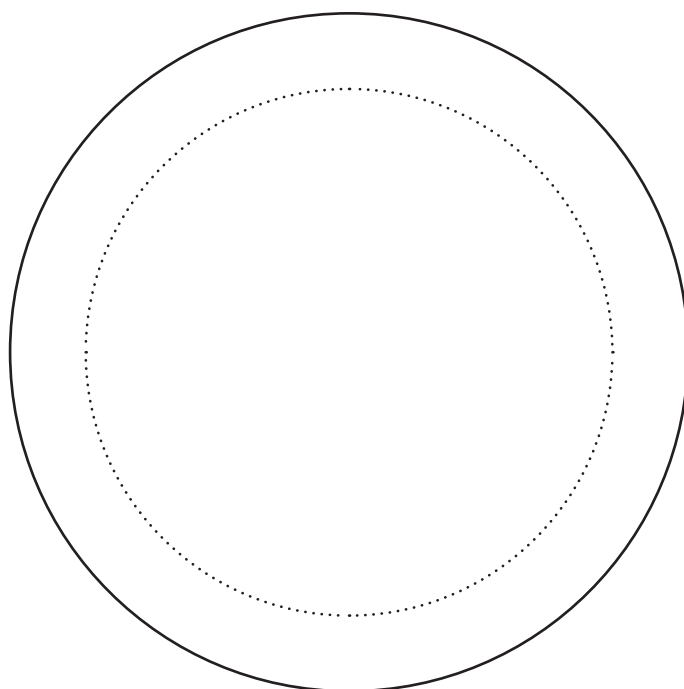
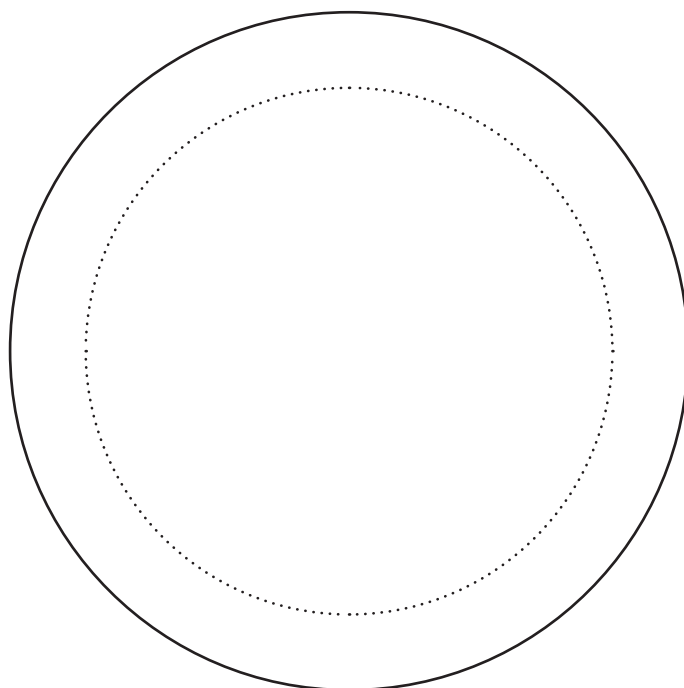
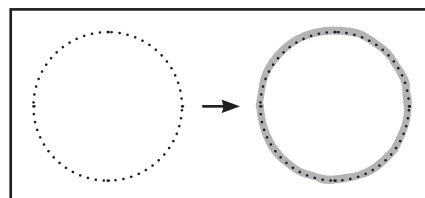

Sledi pikčastim črtam in riši kroge.

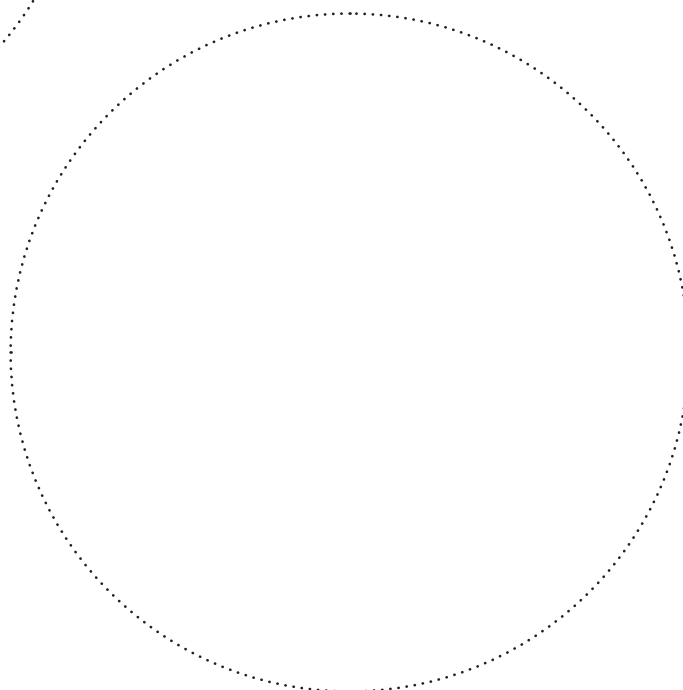
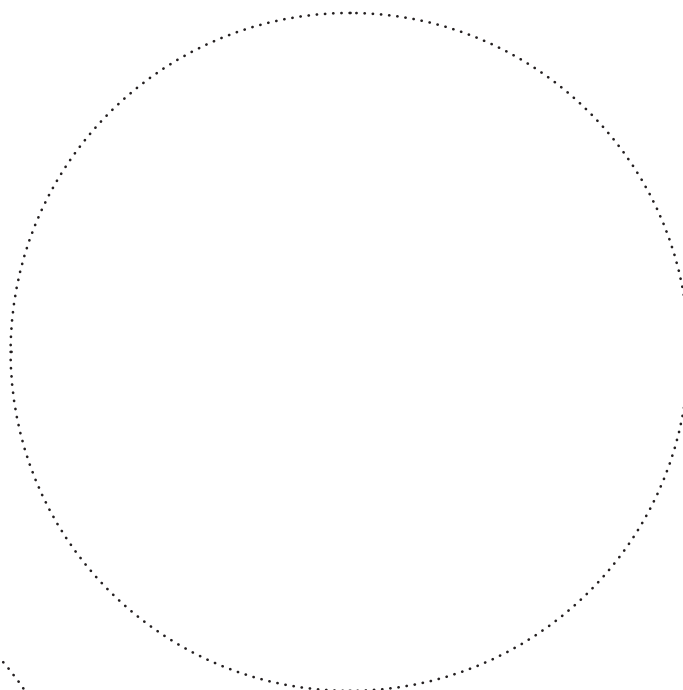
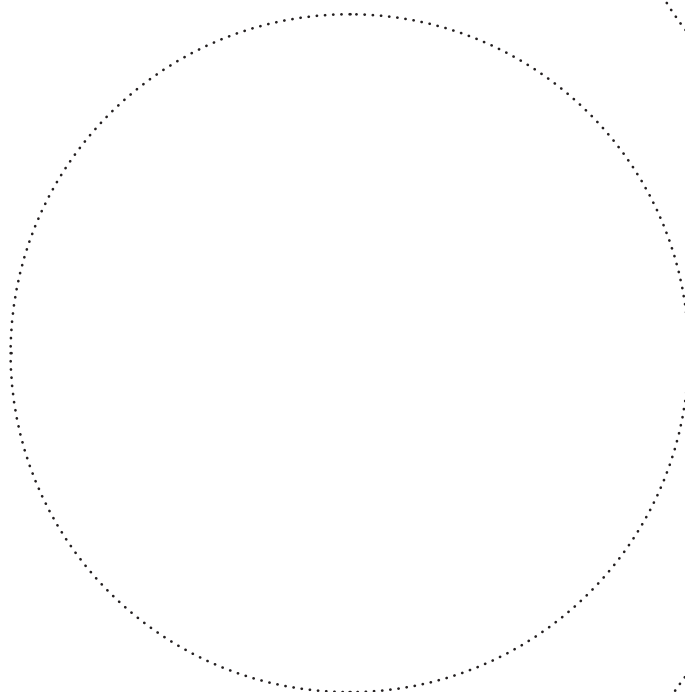
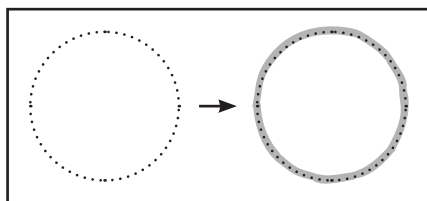

Sledi pikčastim črtam in riši kroge.

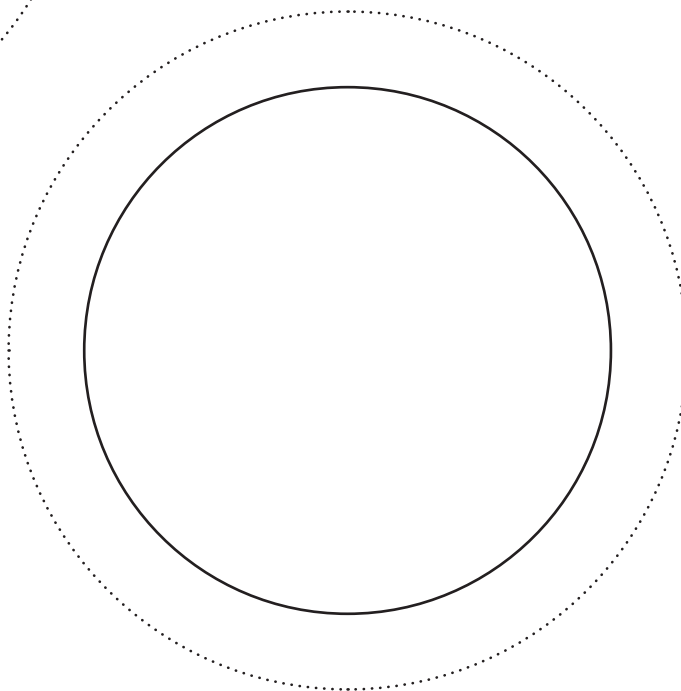
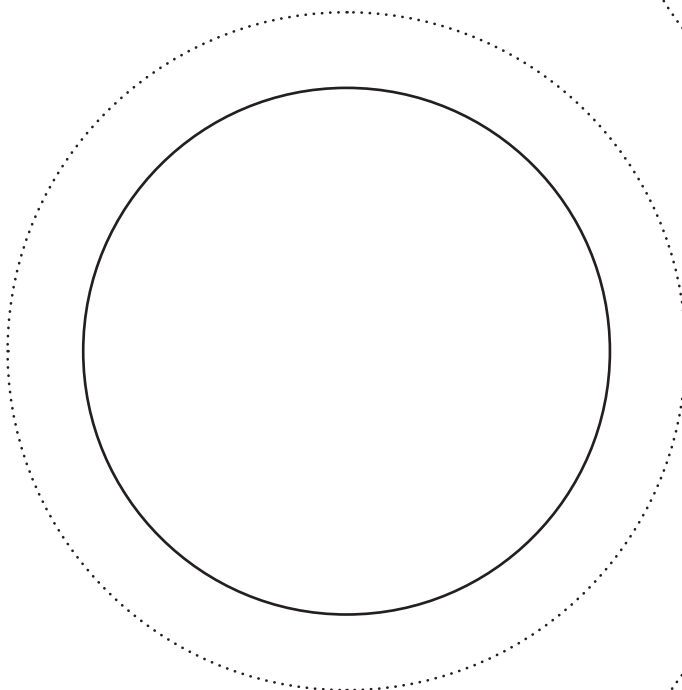
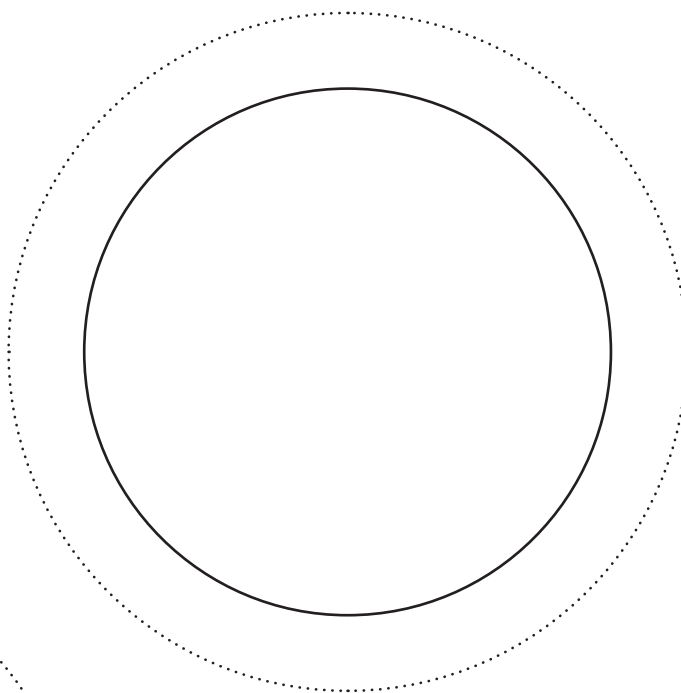
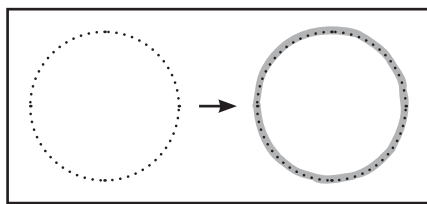

Sledi pikčastim črtam in riši kroge.

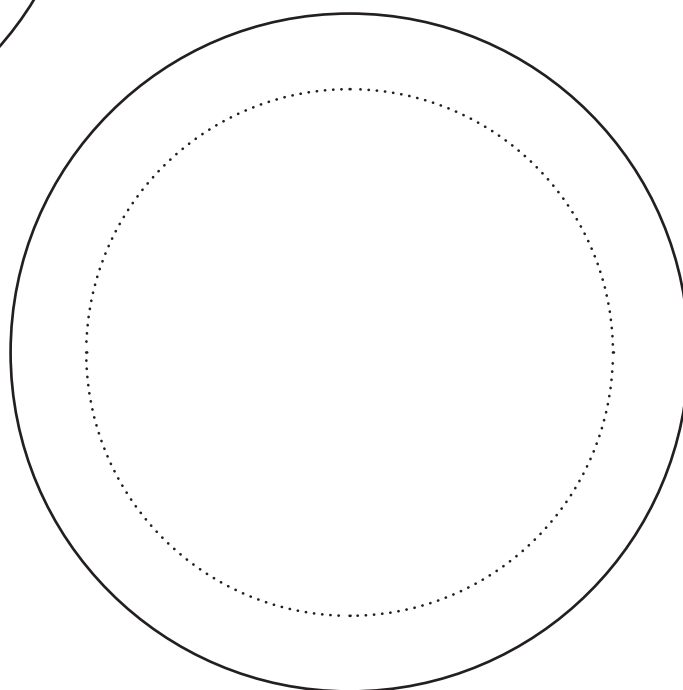
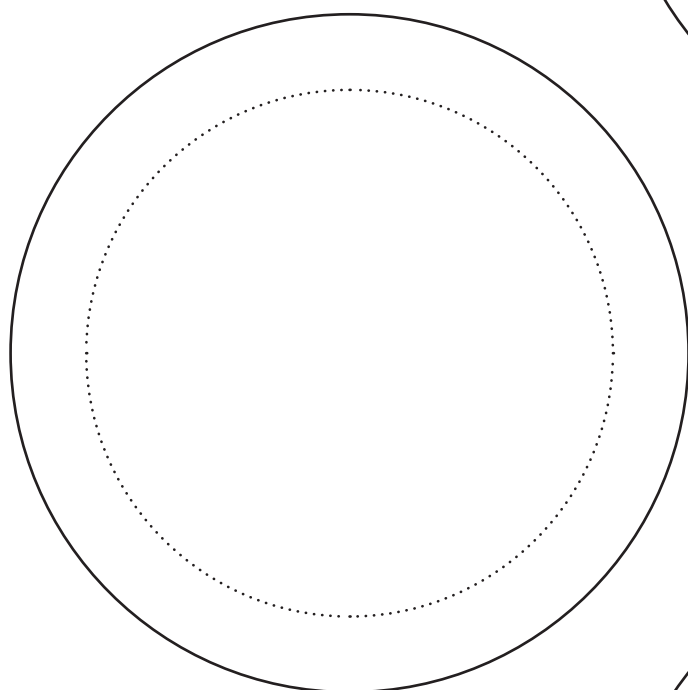
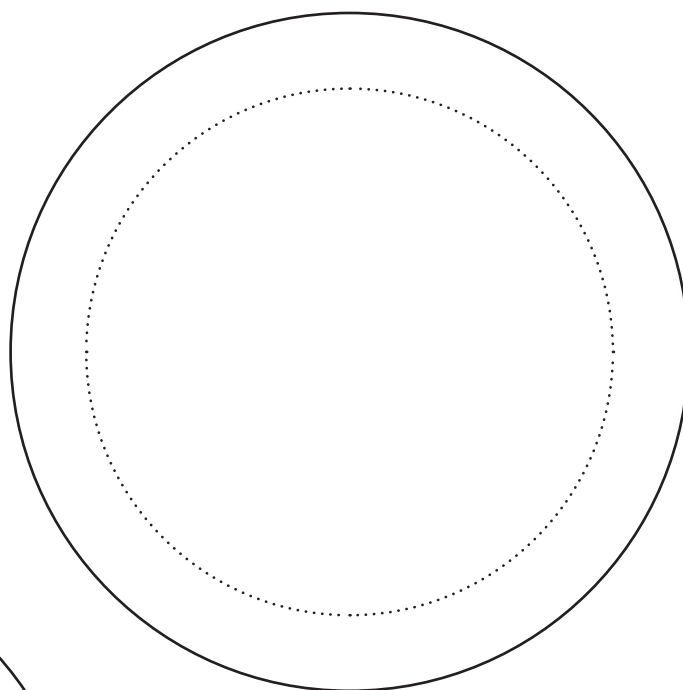
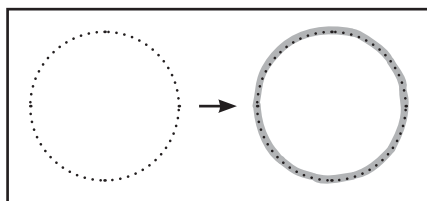

Sledi pikčastim črtam in riši kroge.

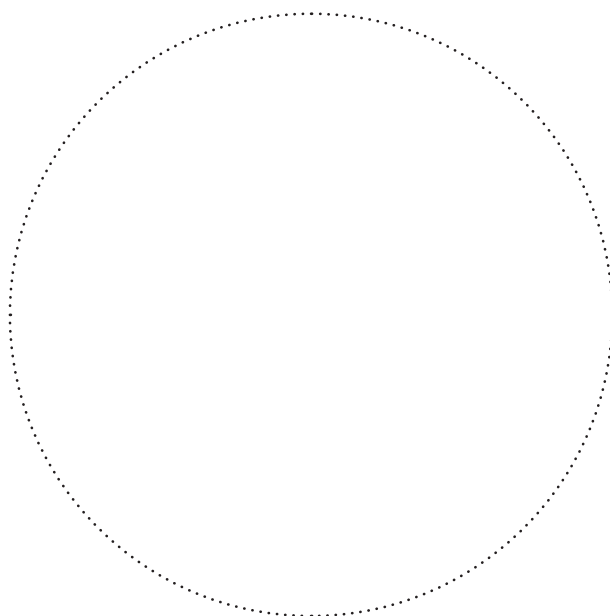
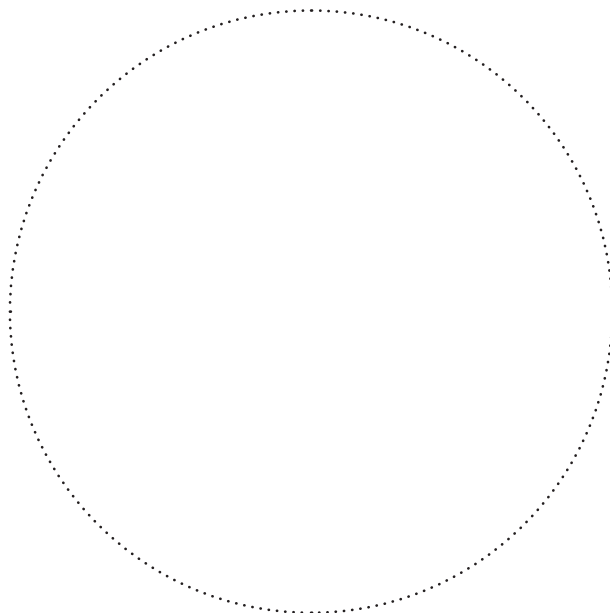
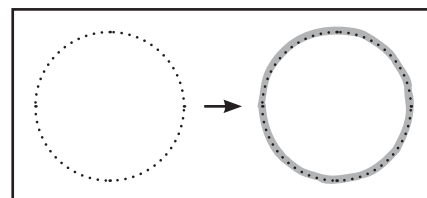

Sledi pikčastim črtam in riši kroge.

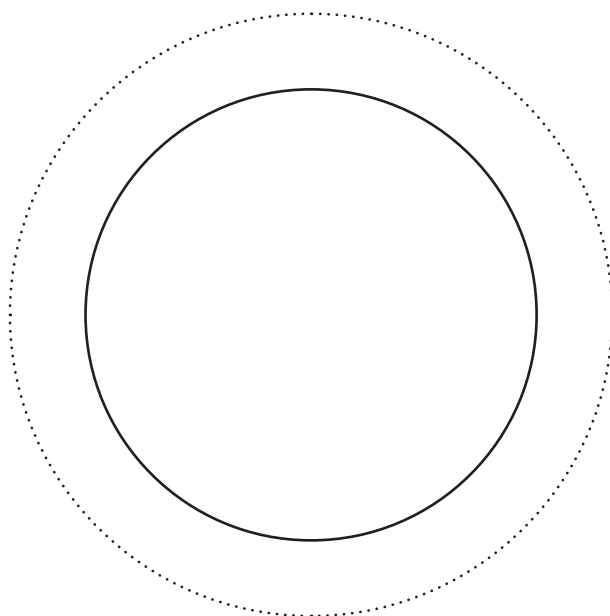
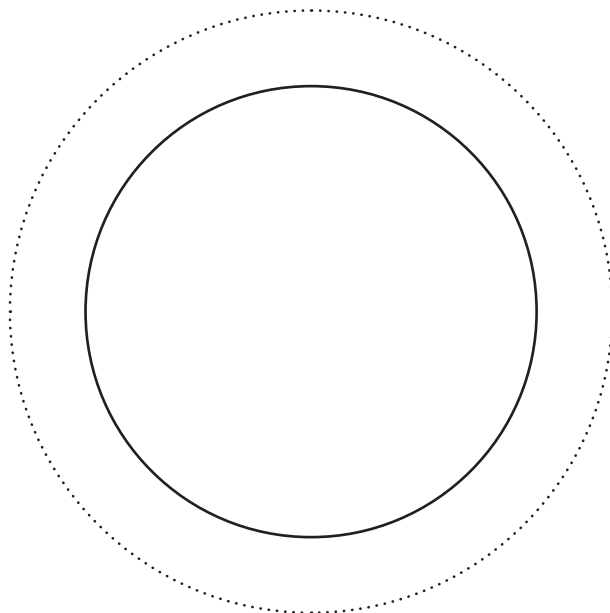
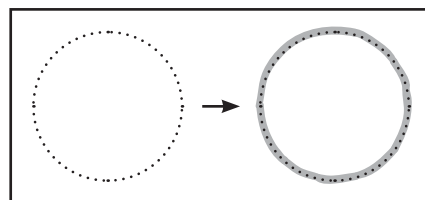

Sledi pikčastim črtam in riši kroge.

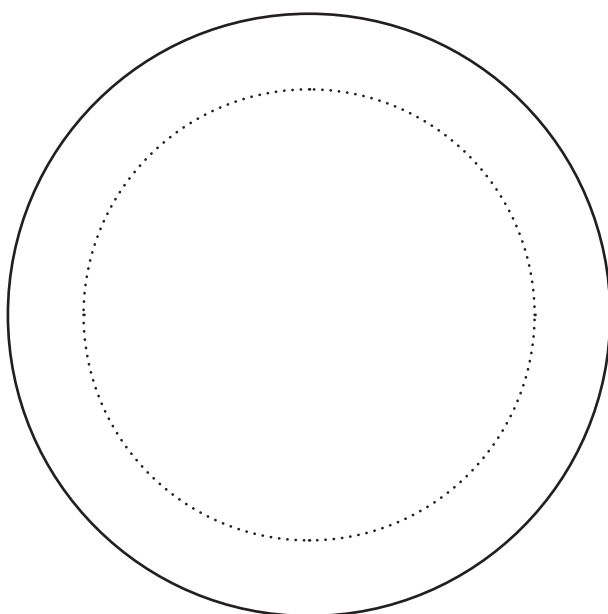
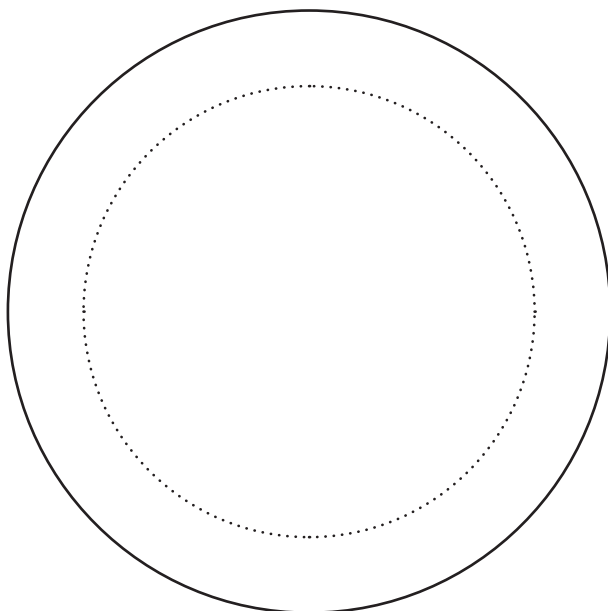
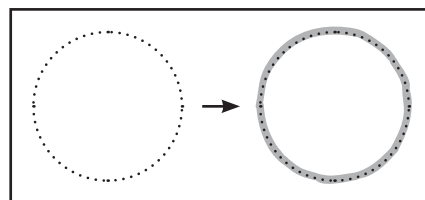

Sledi pikčastim črtam in riši kroge.

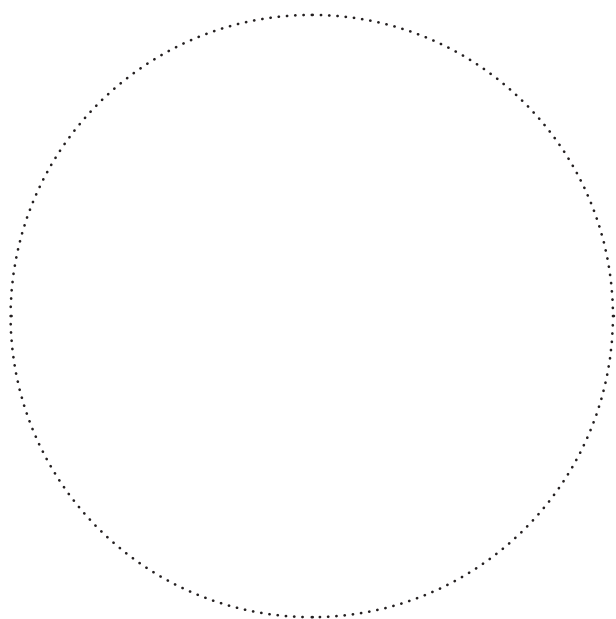
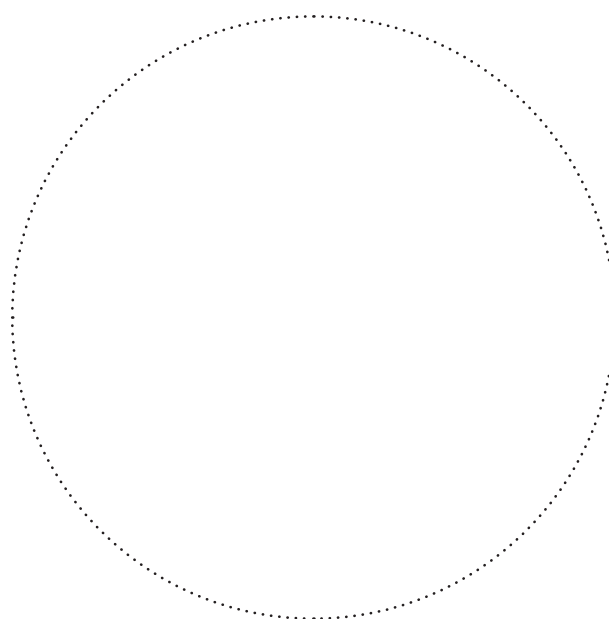
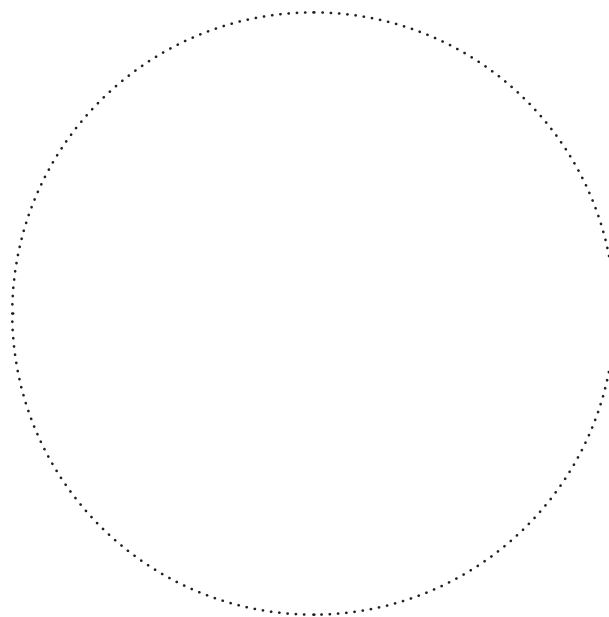
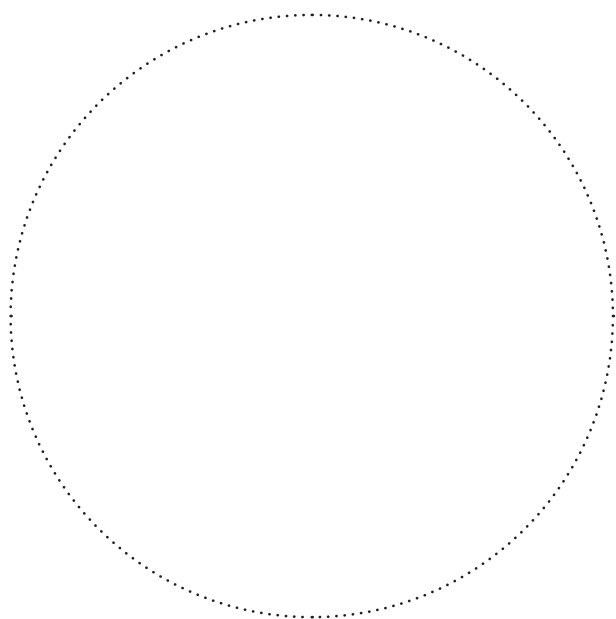
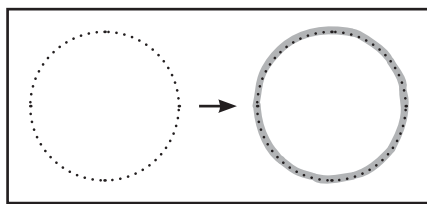

Sledi pikčastim črtam in riši kroge.

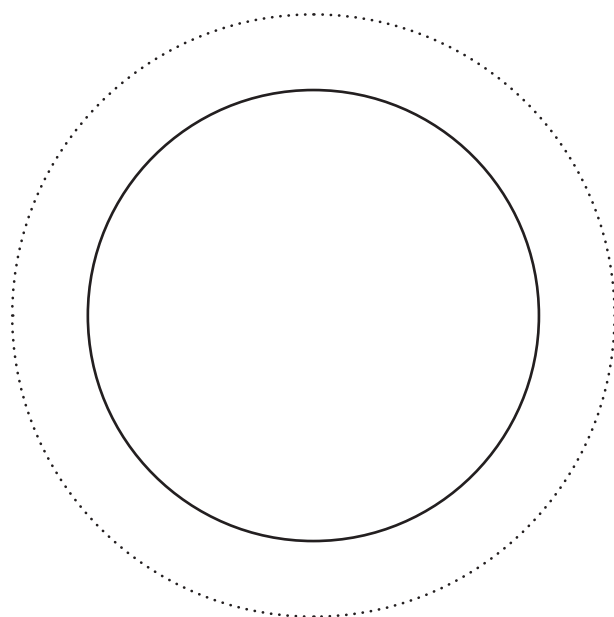
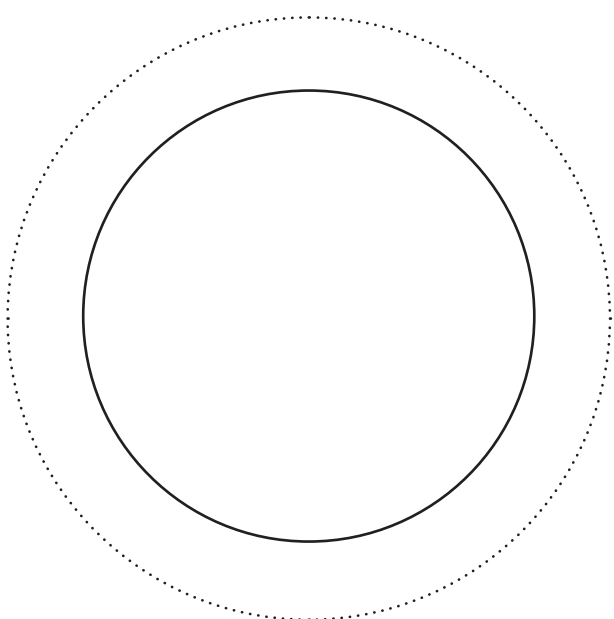
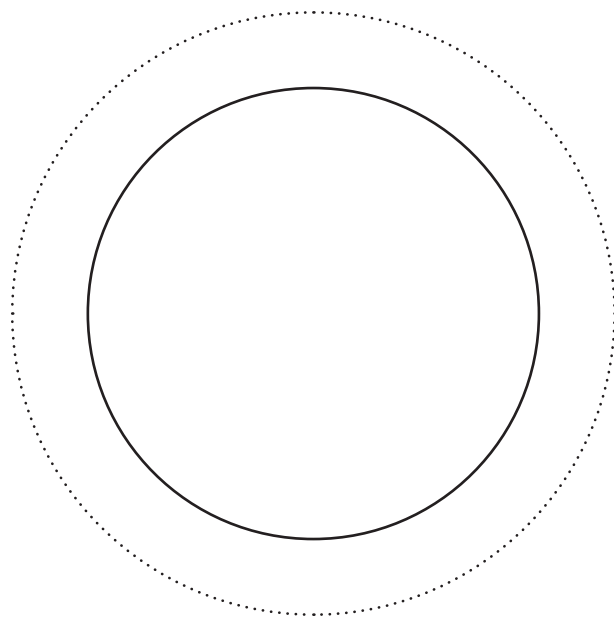
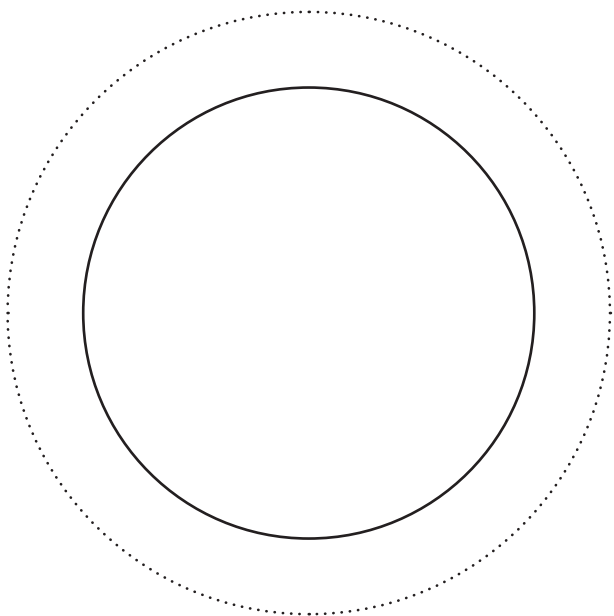
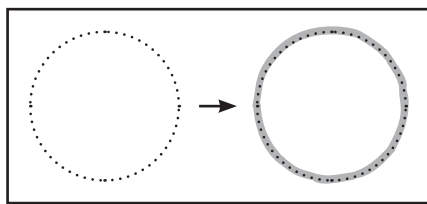

Sledi pikčastim črtam in riši kroge.

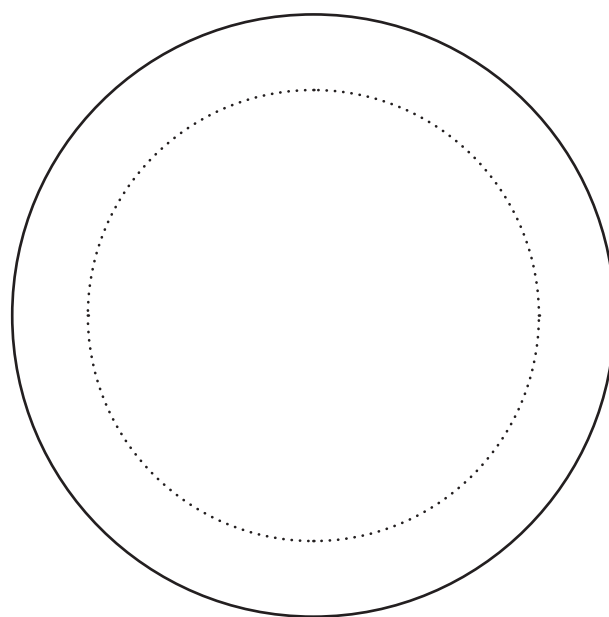
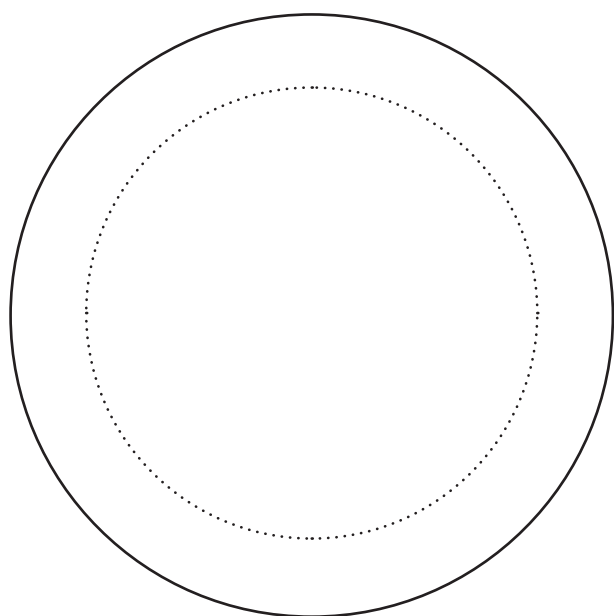
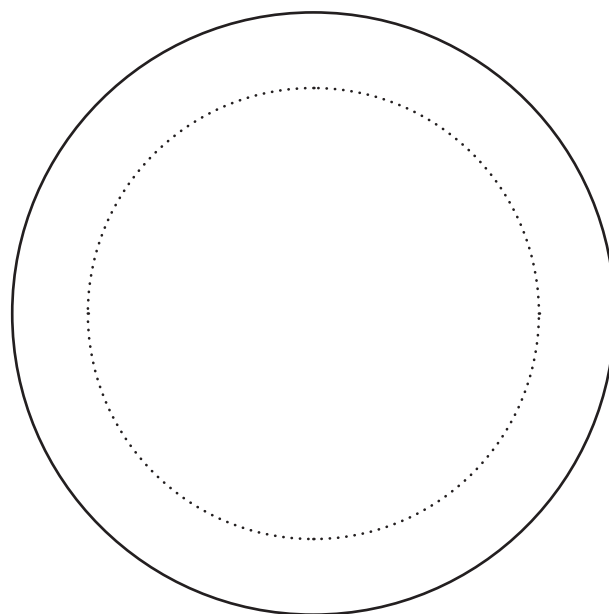
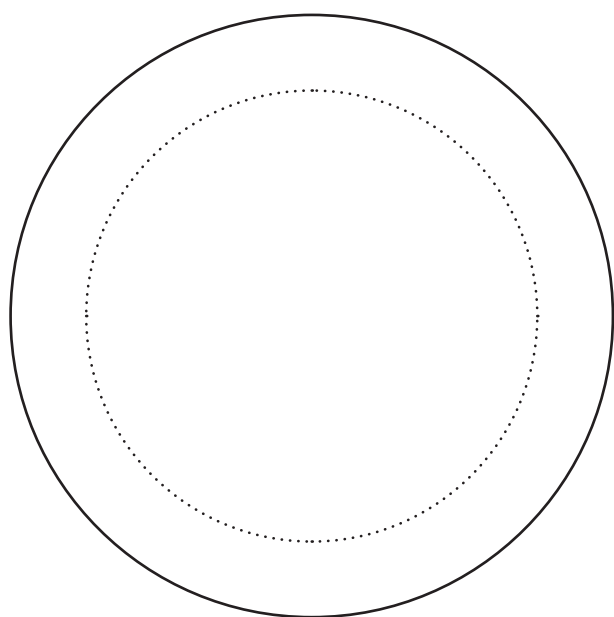
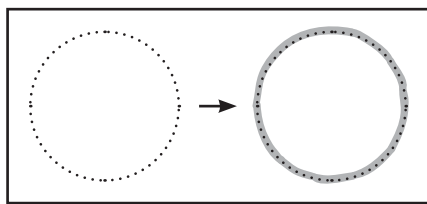

Sledi pikčastim črtam in riši kroge.

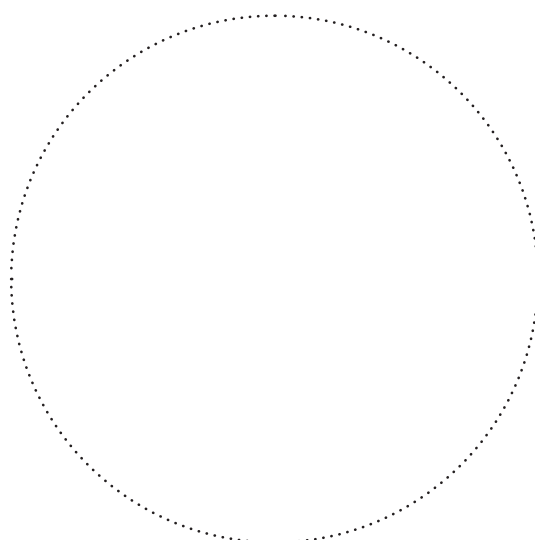
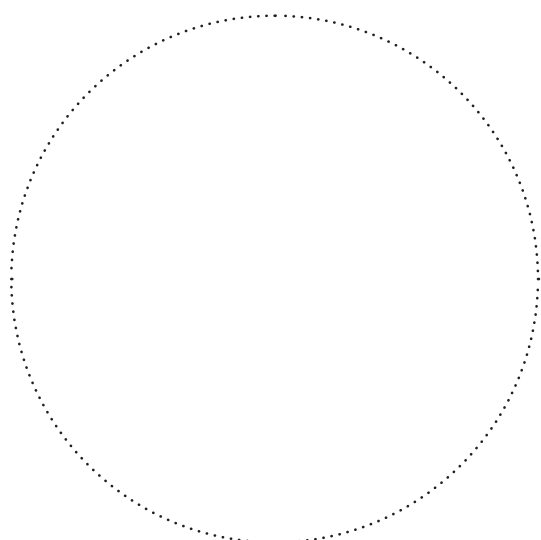
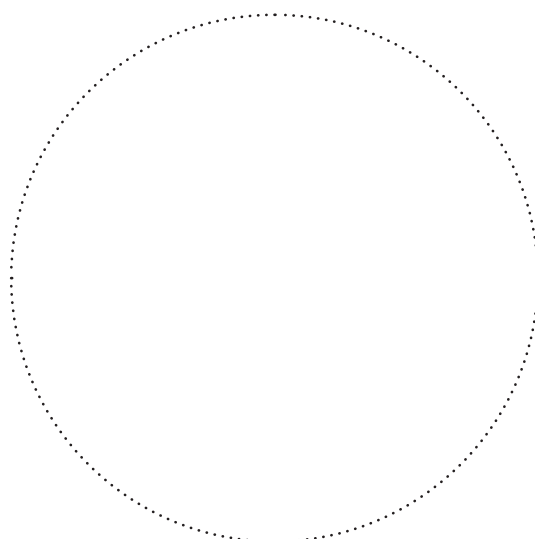
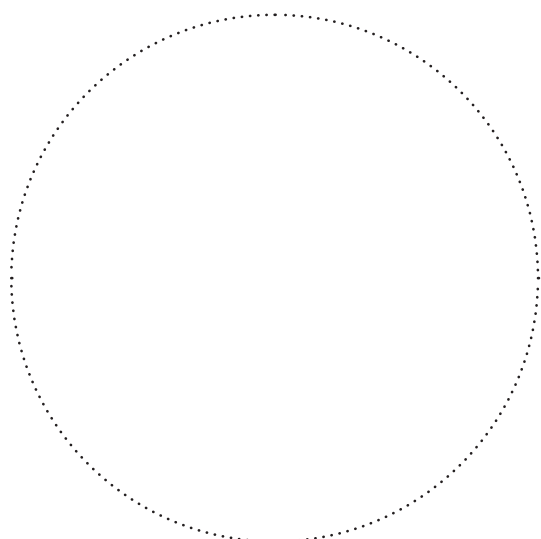
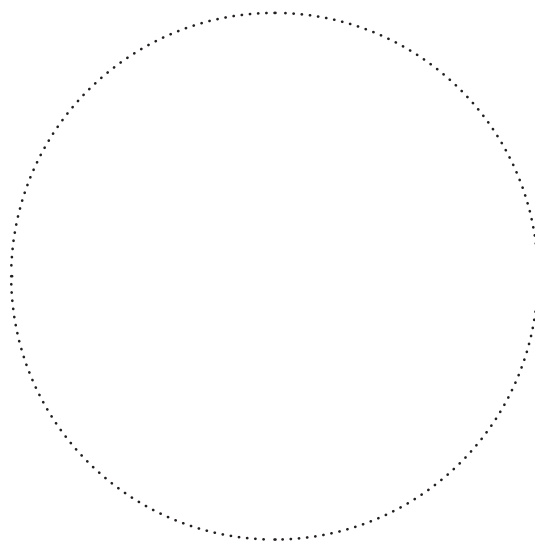
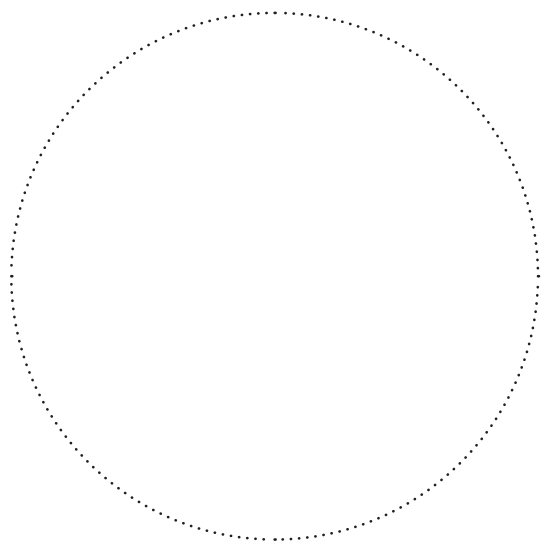
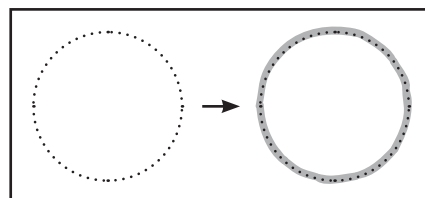

Sledi pikčastim črtam in riši kroge.

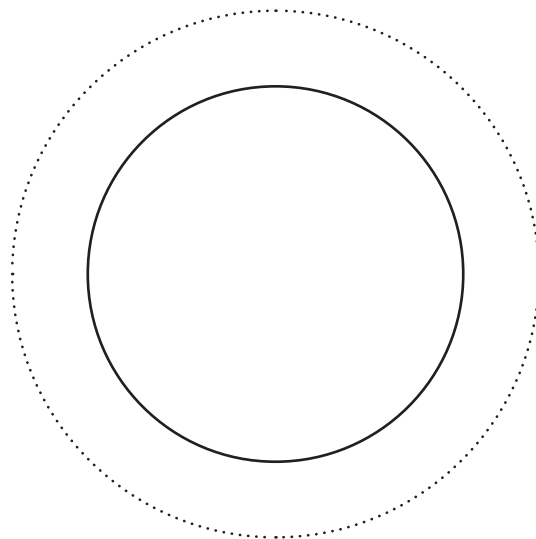
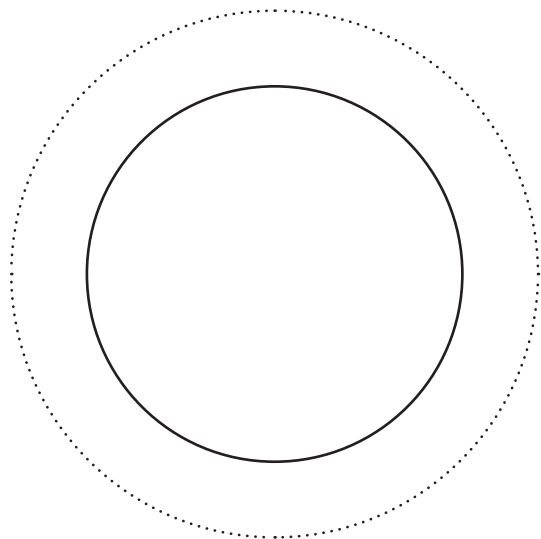
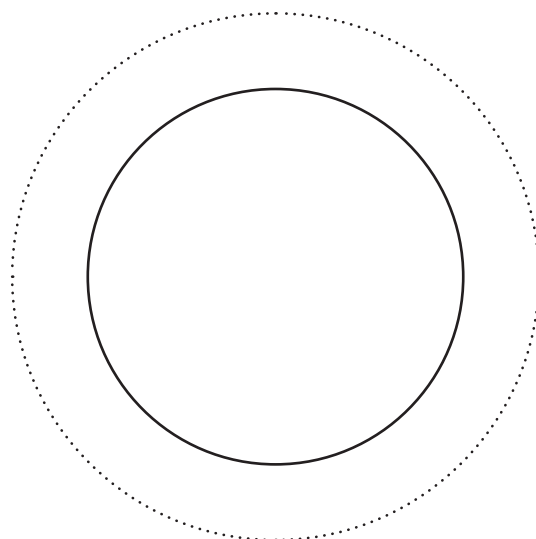
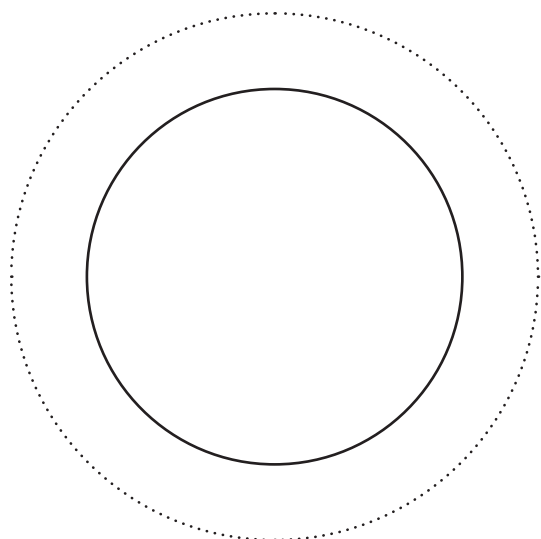
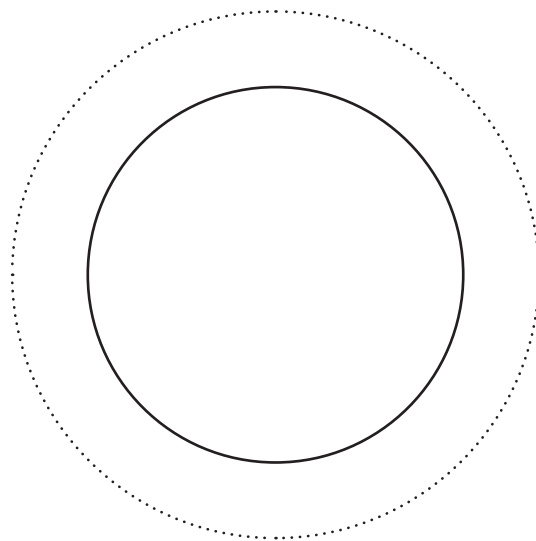
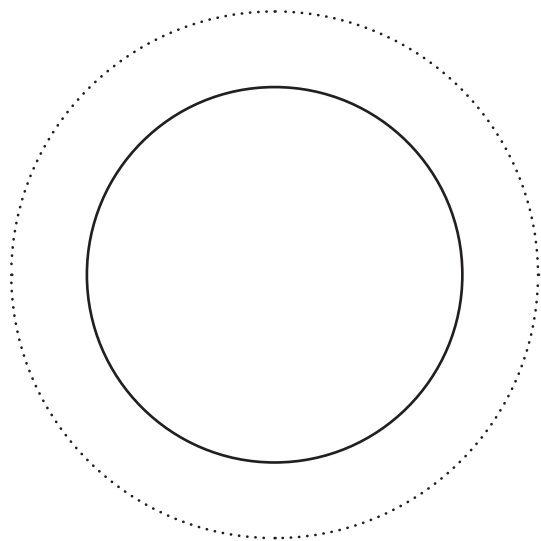
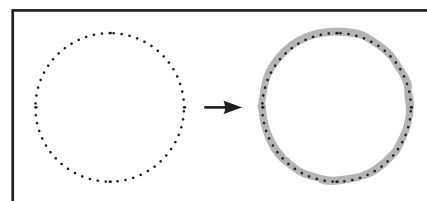

Sledi pikčastim črtam in riši kroge.

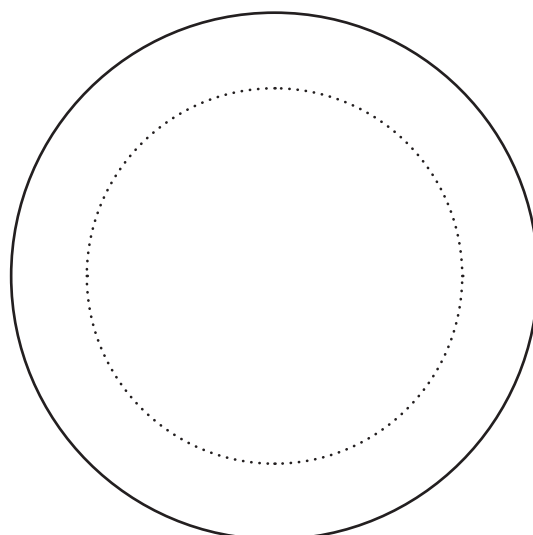
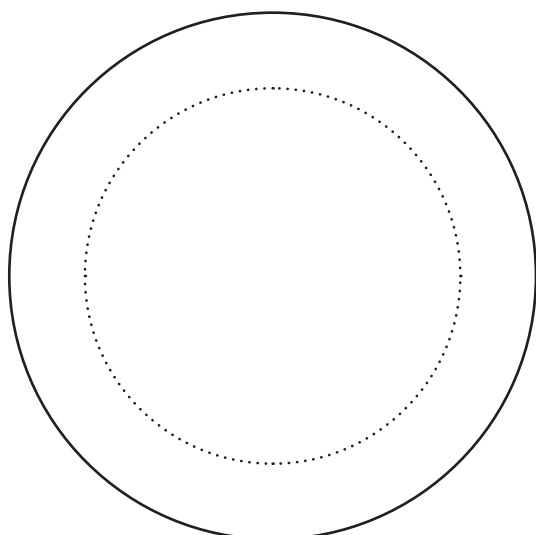
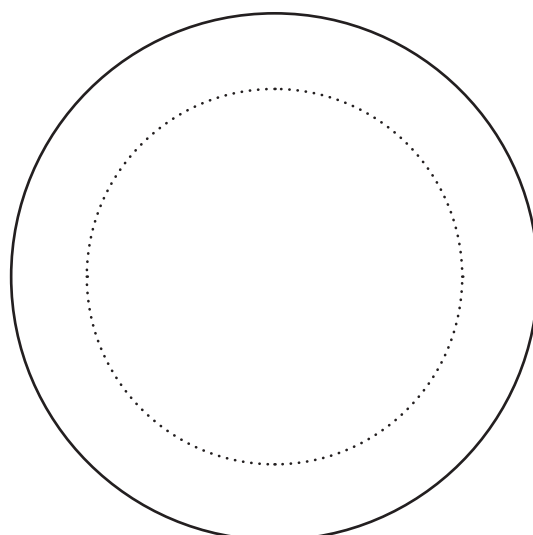
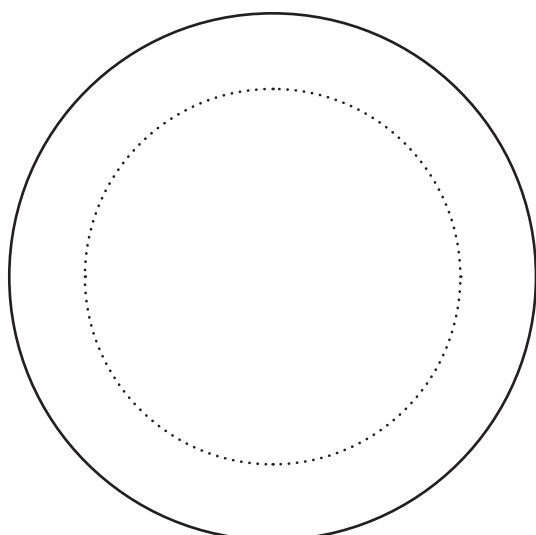
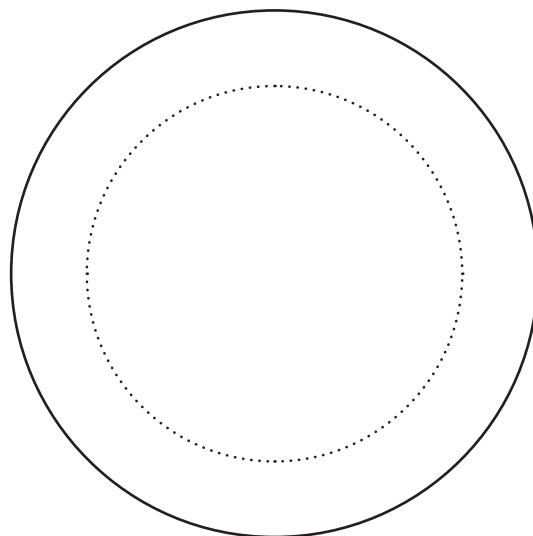
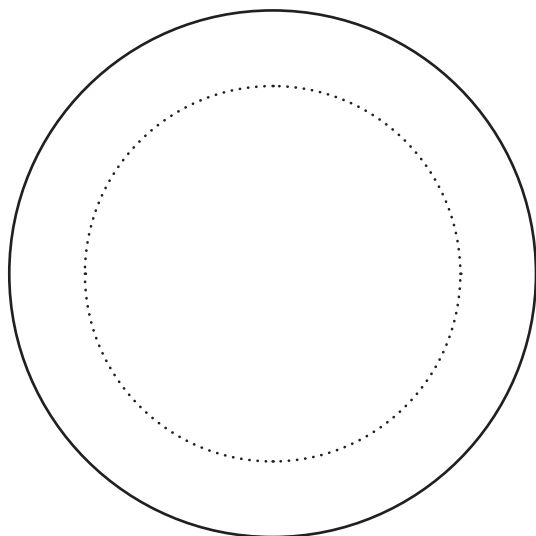
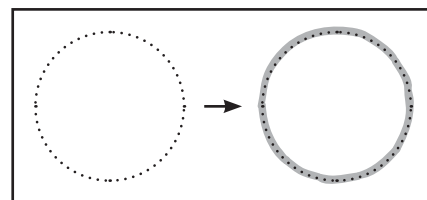

Sledi pikčastim črtam in riši kroge.

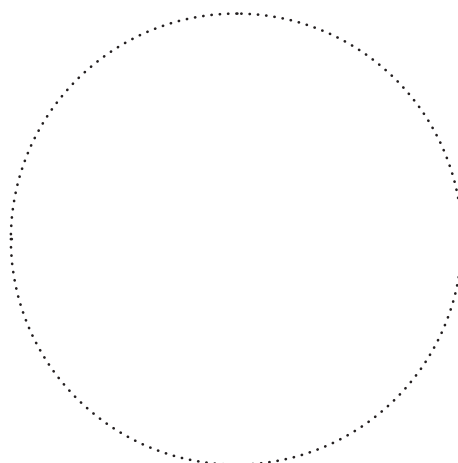
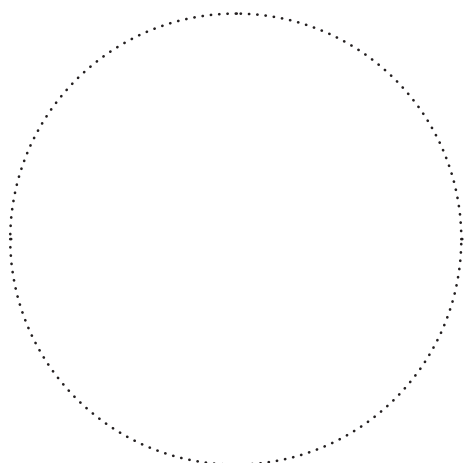
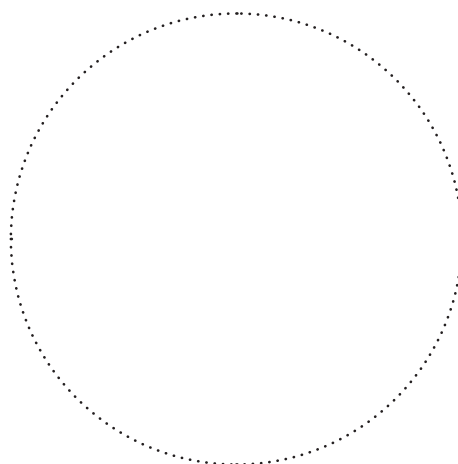
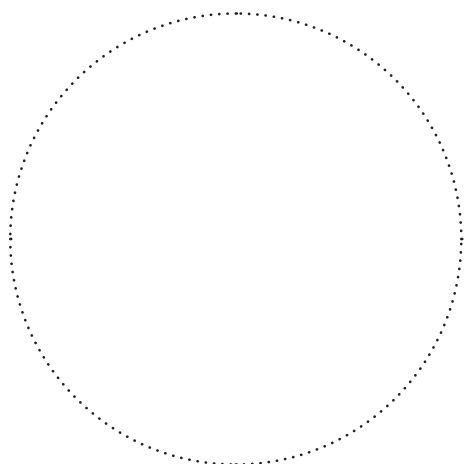
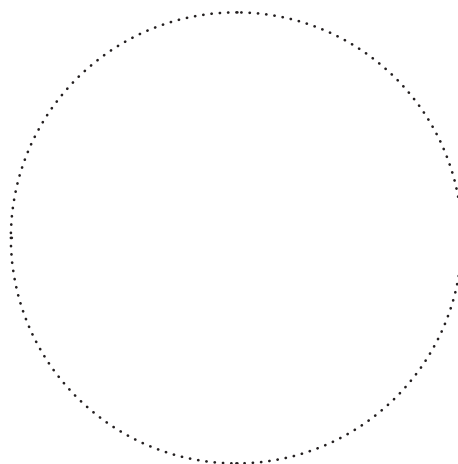
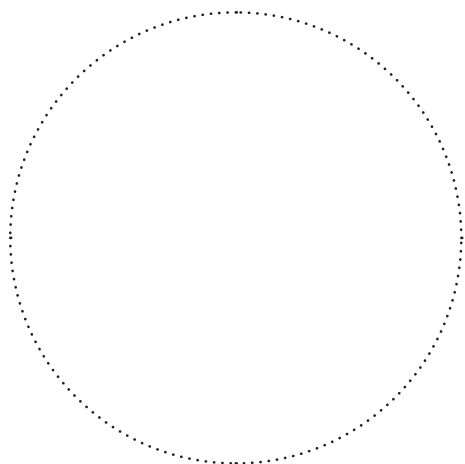
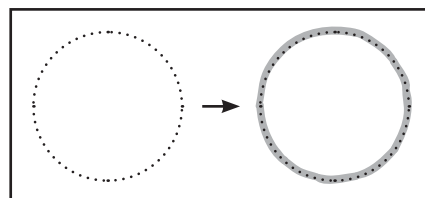

Sledi pikčastim črtam in riši kroge.

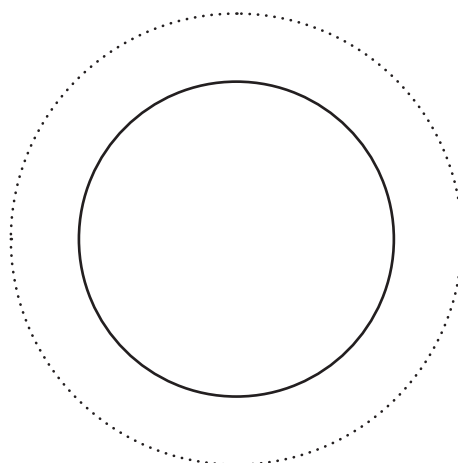
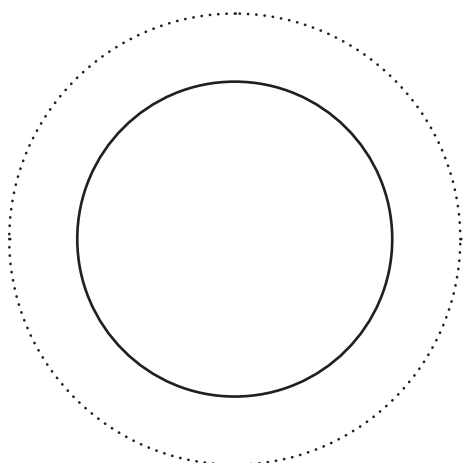
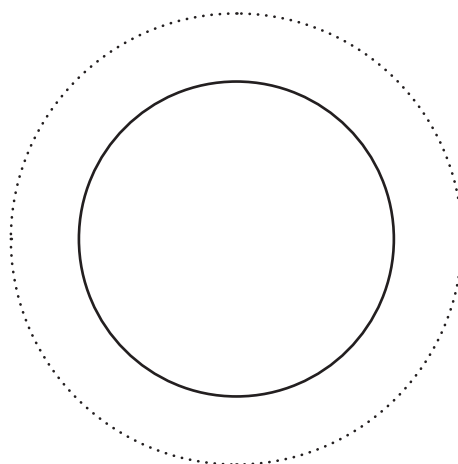
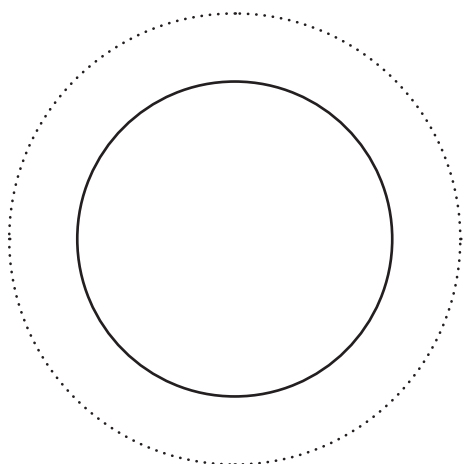
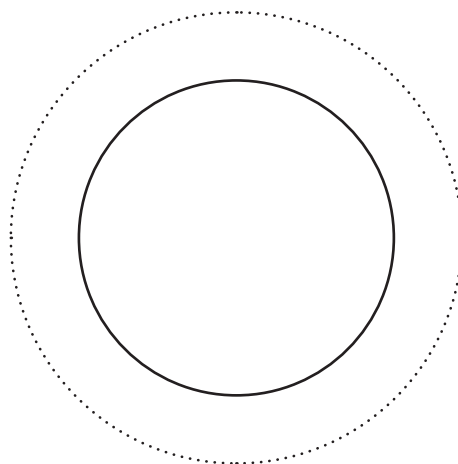
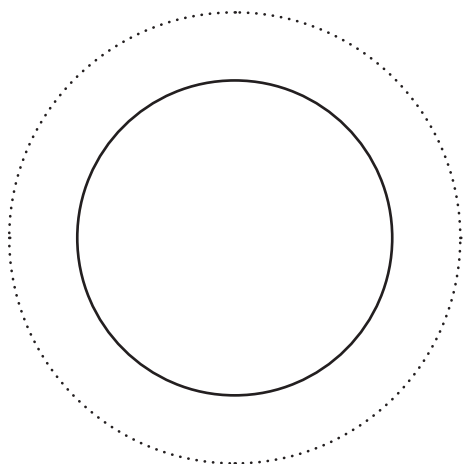
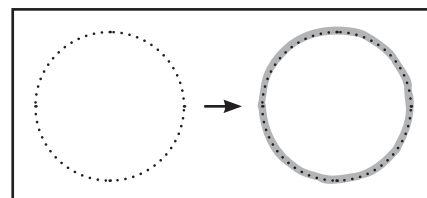

Sledi pikčastim črtam in riši kroge.

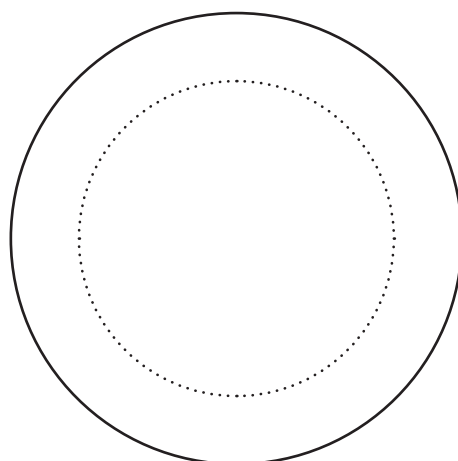
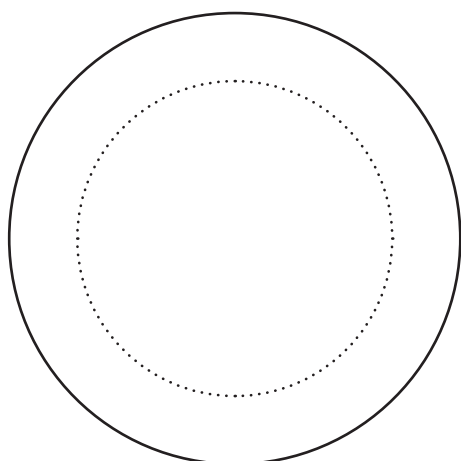
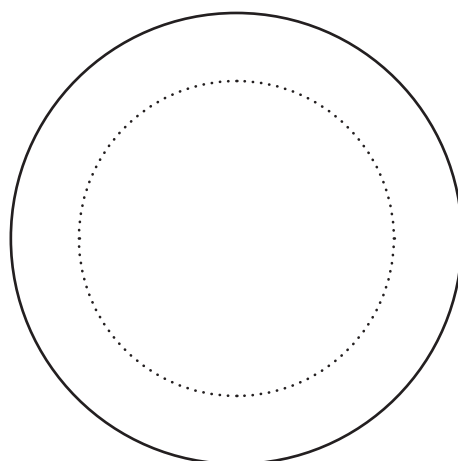
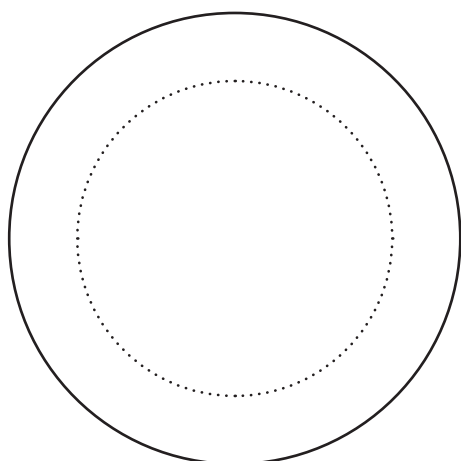
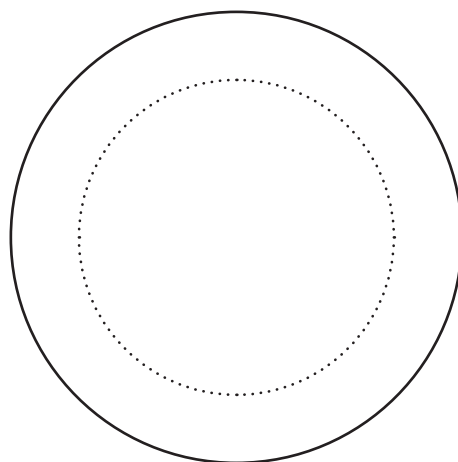
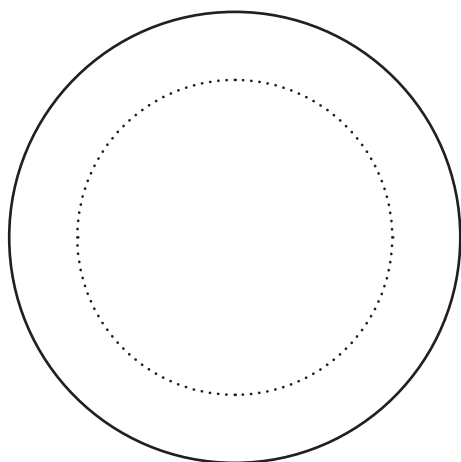
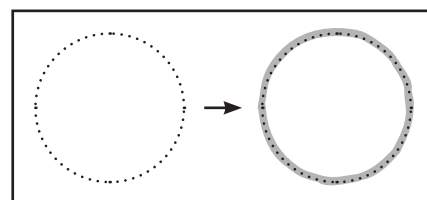

Sledi pikčastim črtam in riši kroge.

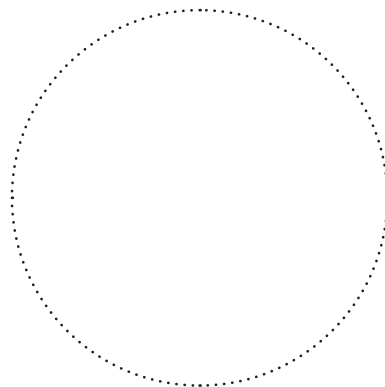
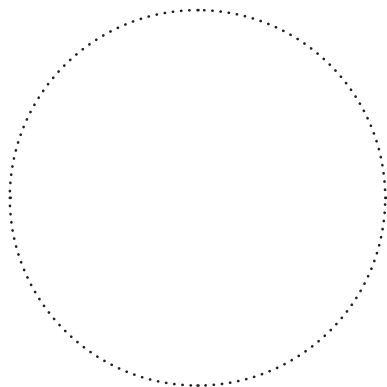
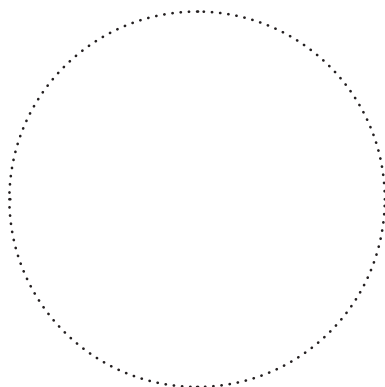
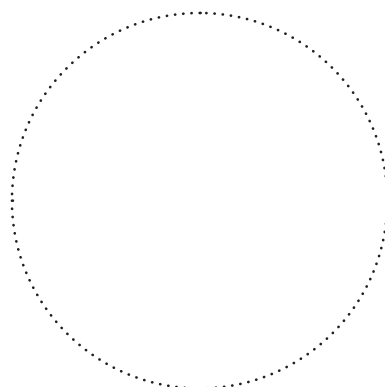
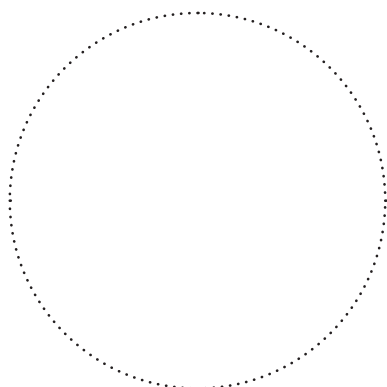
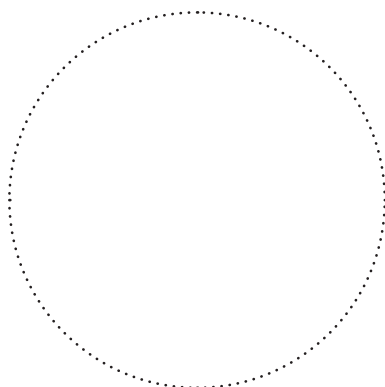
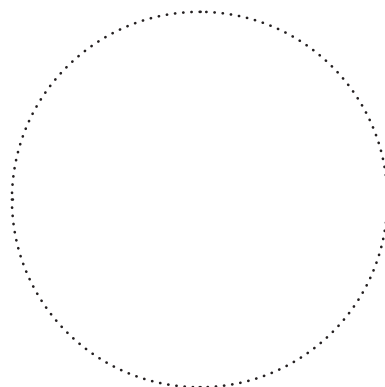
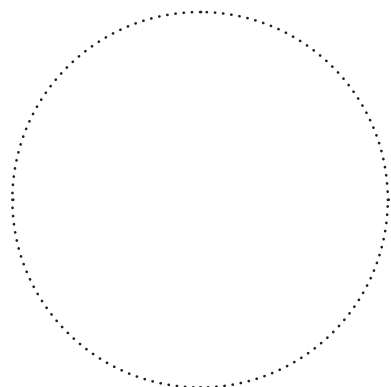
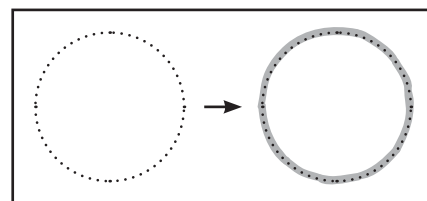

Sledi pikčastim črtam in riši kroge.

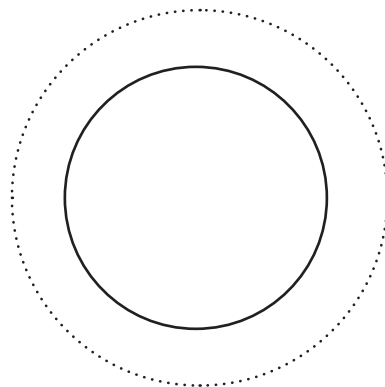
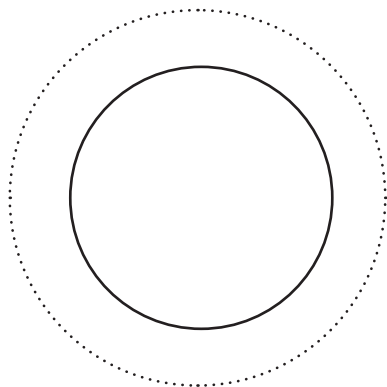
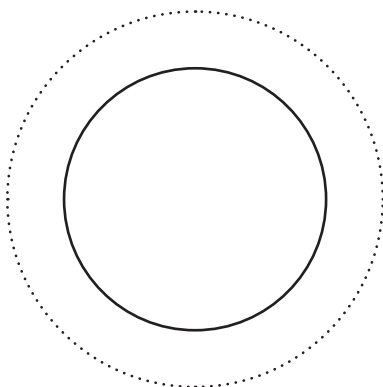
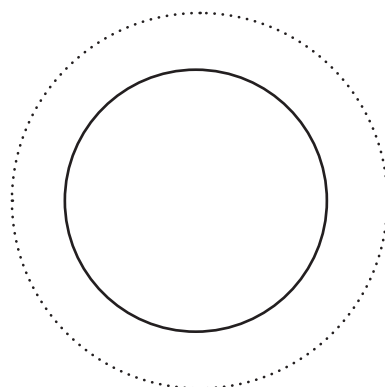
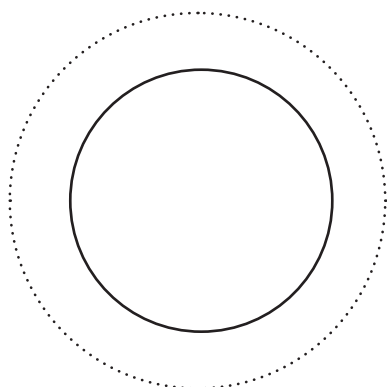
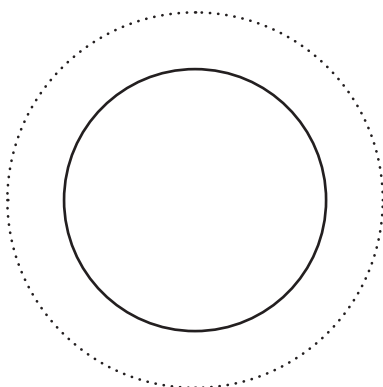
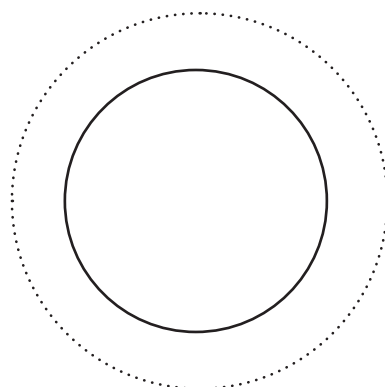
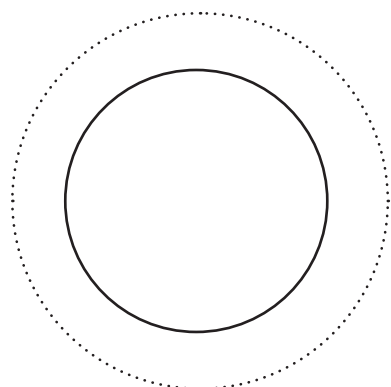
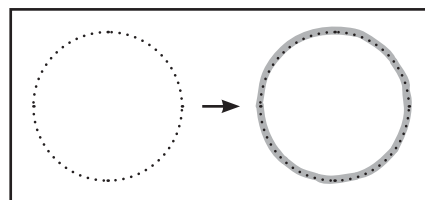

Sledi pikčastim črtam in riši kroge.

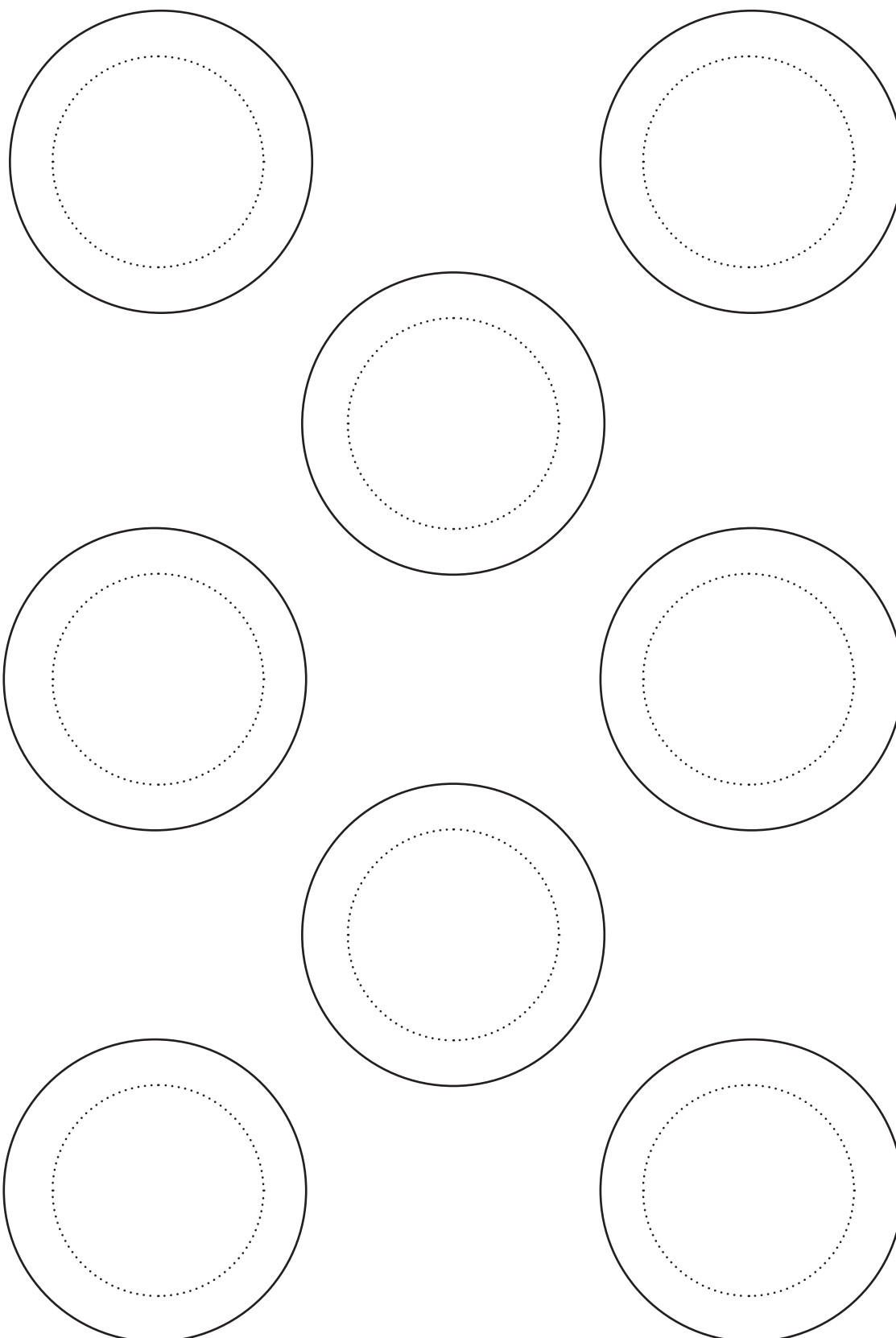
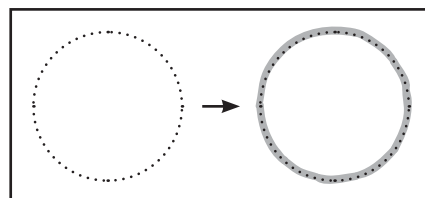

Sledi pikčastim črtam in riši kroge.

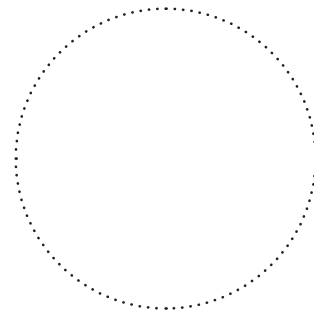
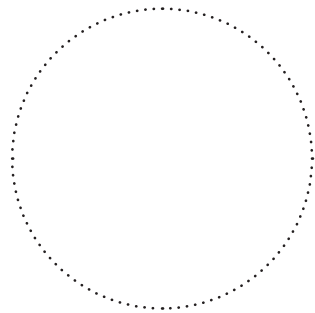
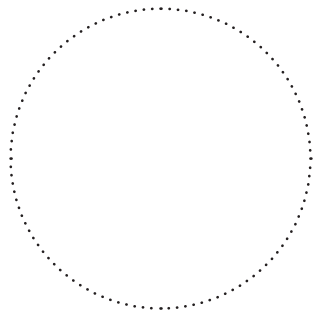
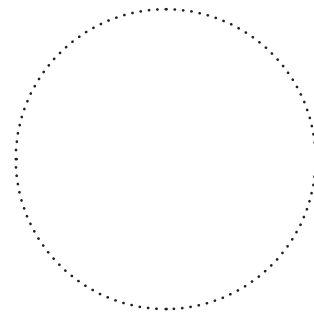
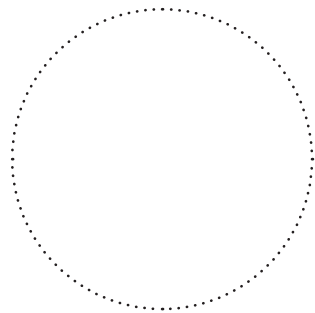
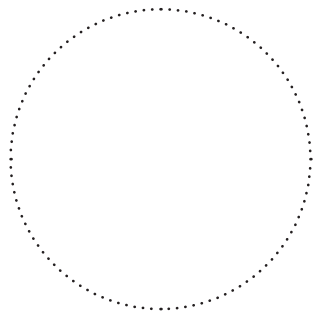
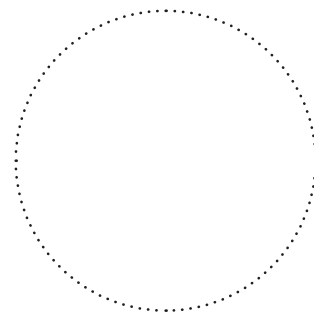
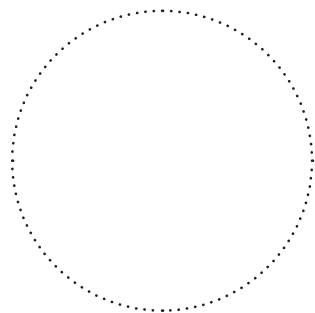
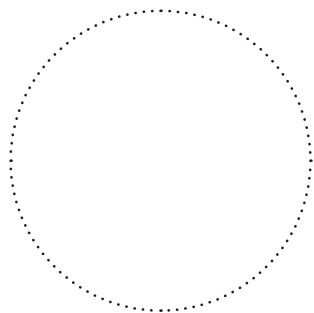
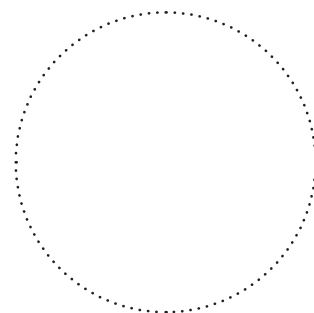
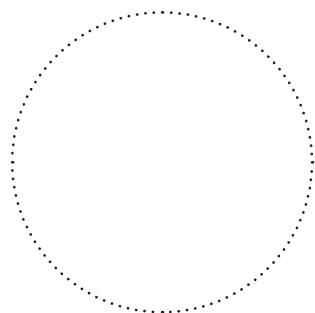
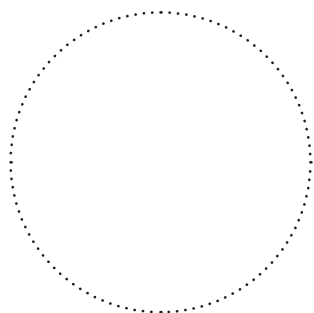
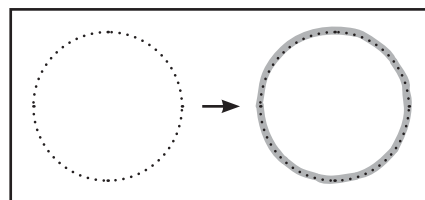

Sledi pikčastim črtam in riši kroge.

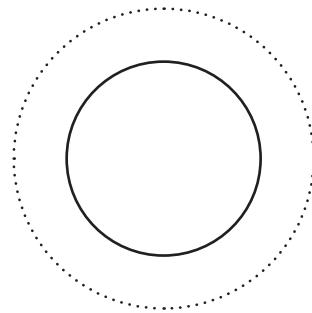
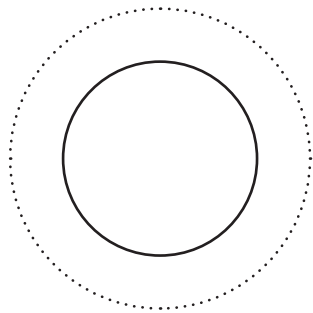
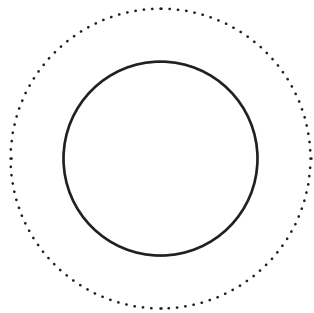
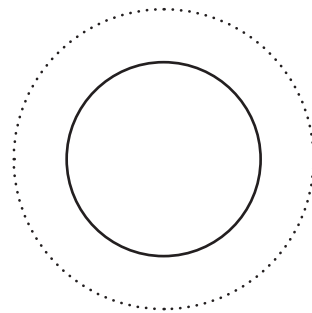
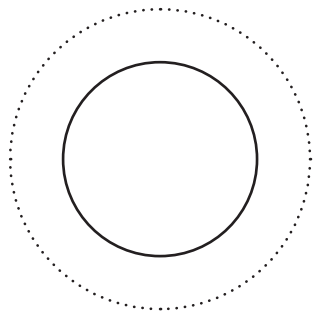
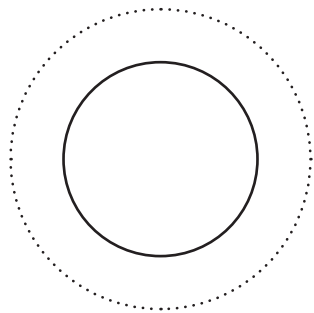
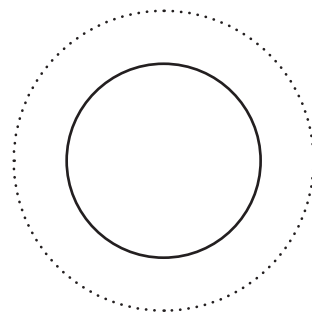
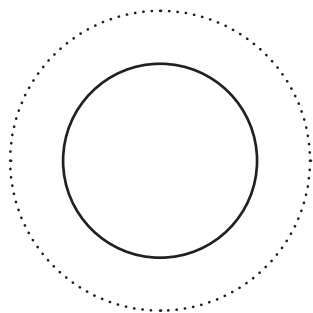
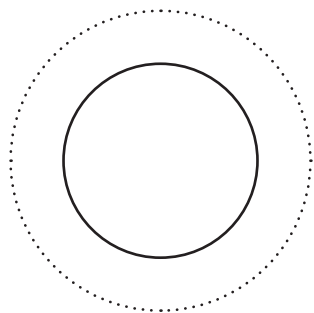
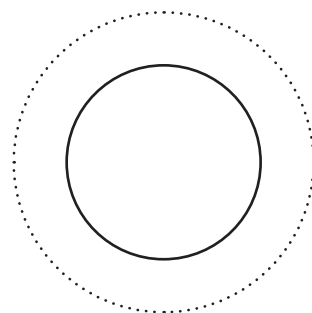
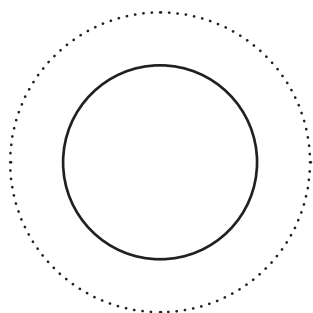
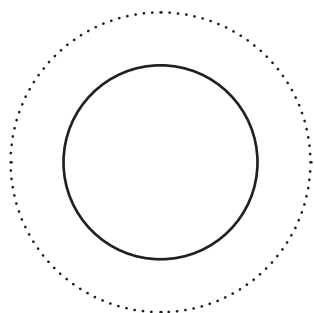
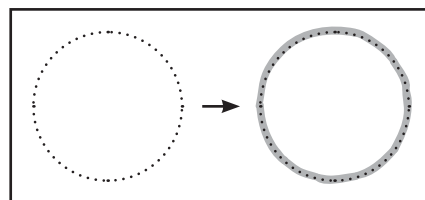

Sledi pikčastim črtam in riši kroge.

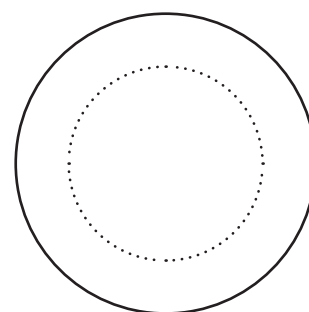
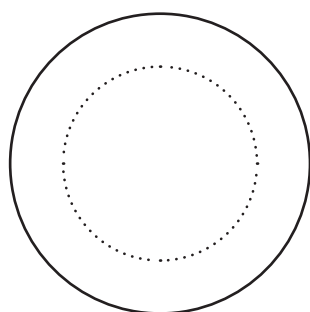
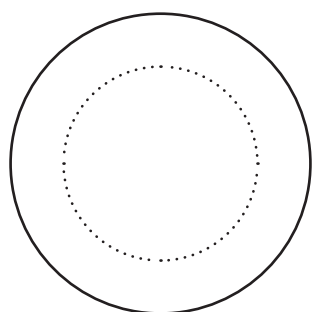
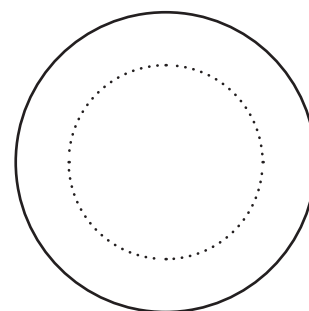
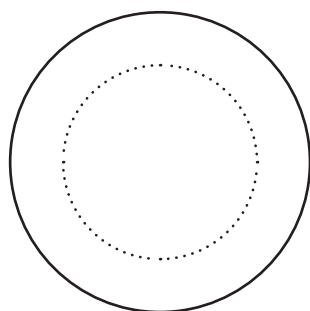
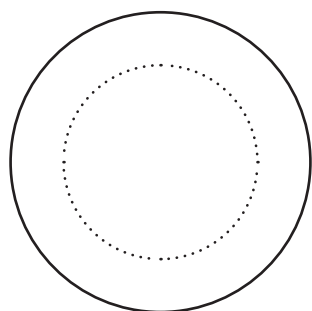
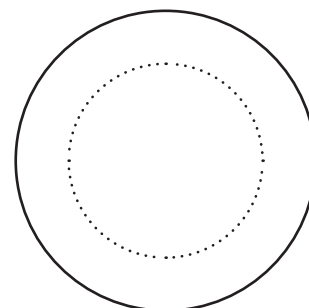
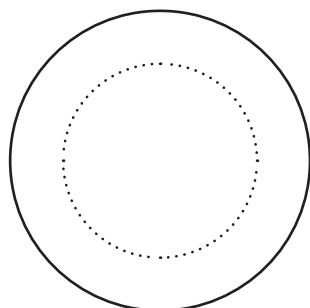
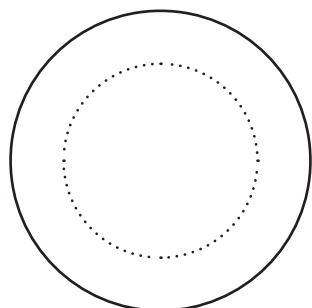
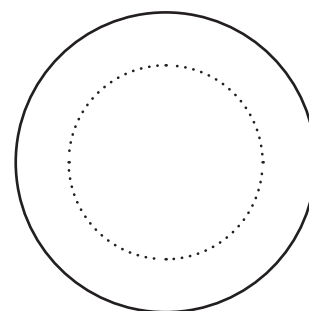
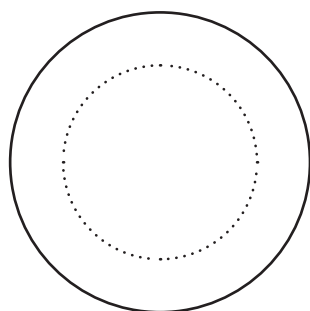
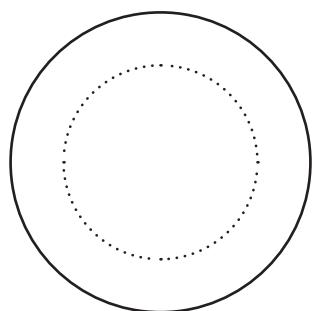
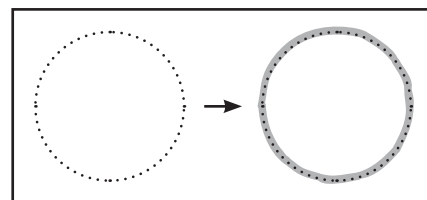

Sledi pikčastim črtam in riši kroge.

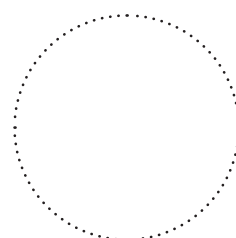
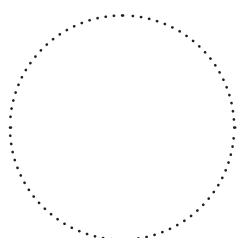
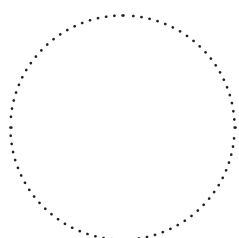
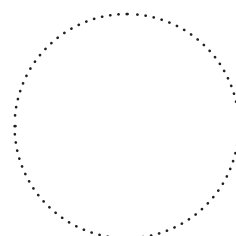
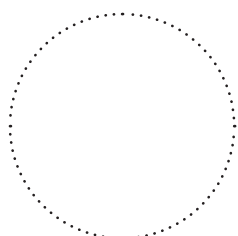
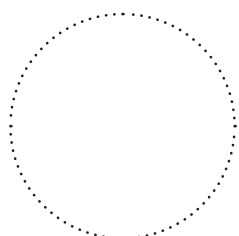
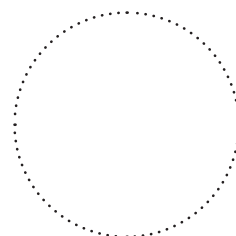
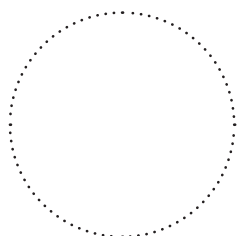
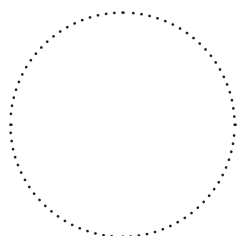
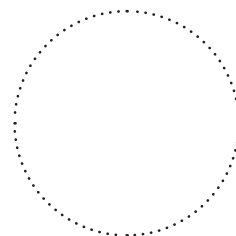
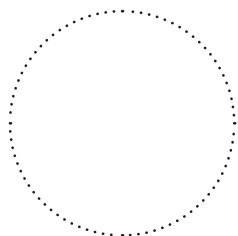
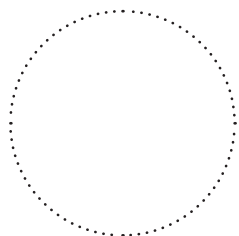
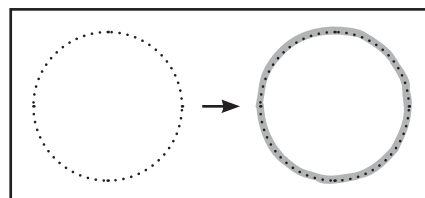

Sledi pikčastim črtam in riši kroge.

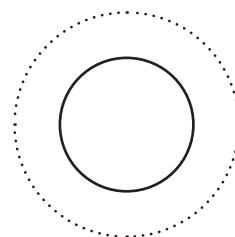
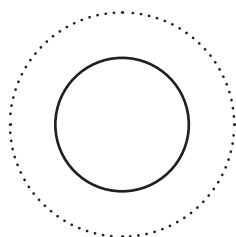
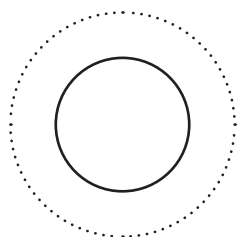
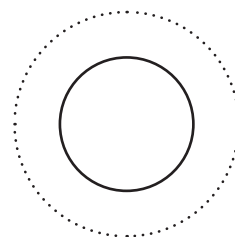
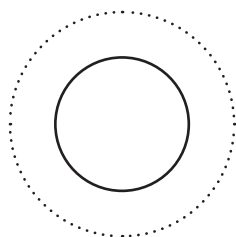
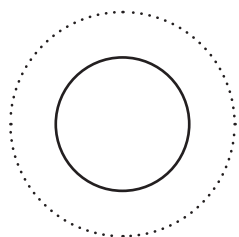
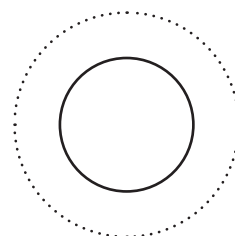
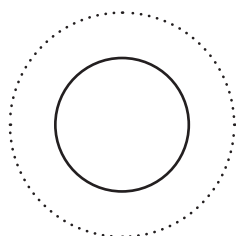
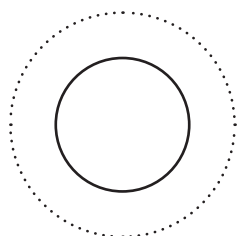
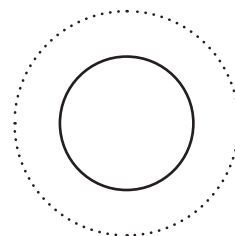
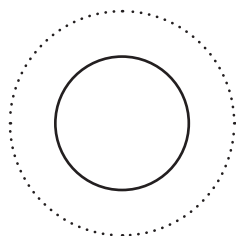
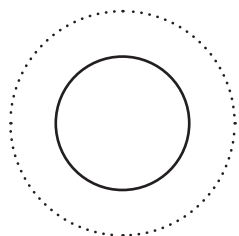
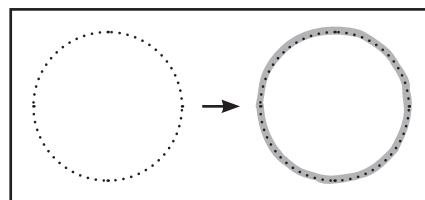

Sledi pikčastim črtam in riši kroge.

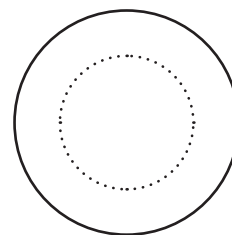
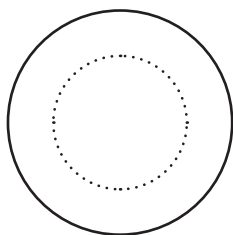
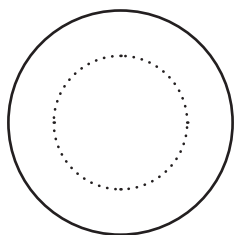
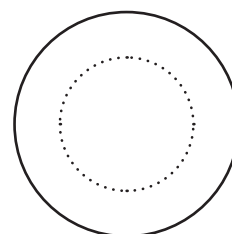
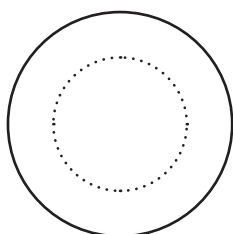
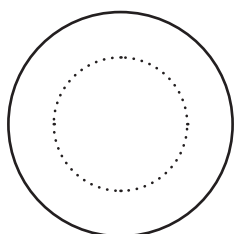
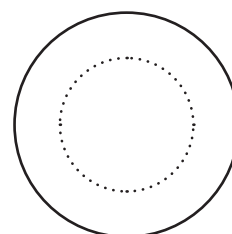
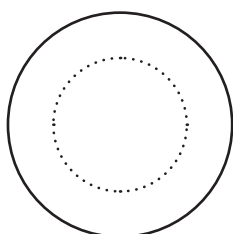
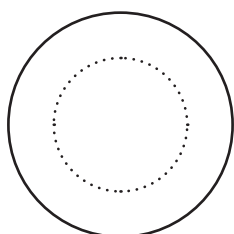
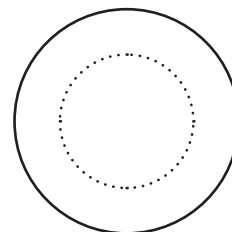
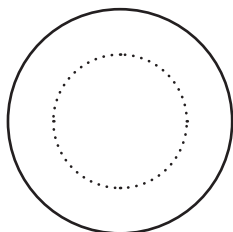
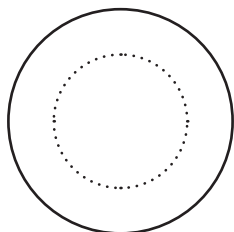
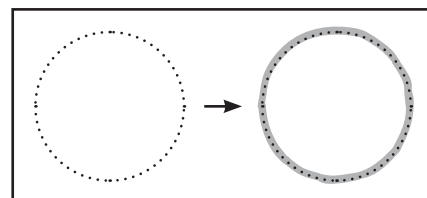

Sledi pikčastim črtam in riši kroge.

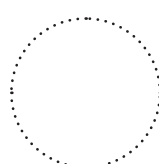
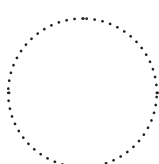
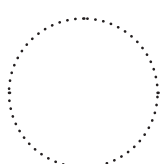
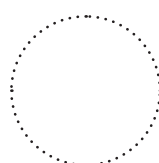
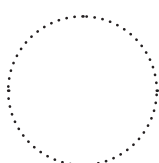
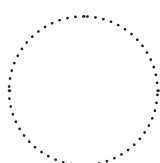
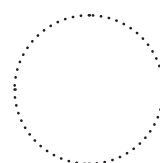
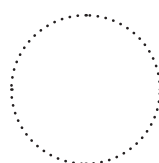
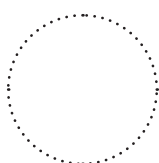
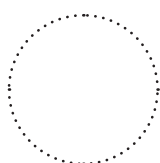
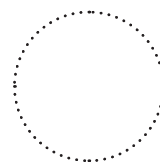
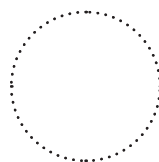
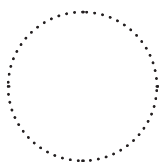
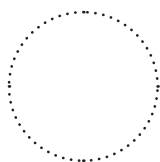
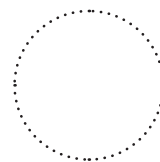
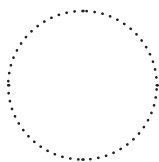
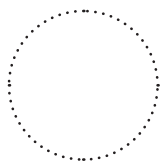
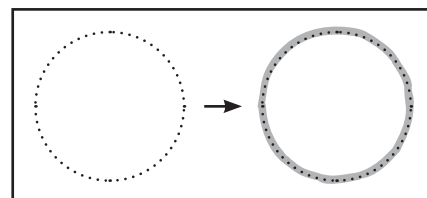

Sledi pikčastim črtam in riši kroge.

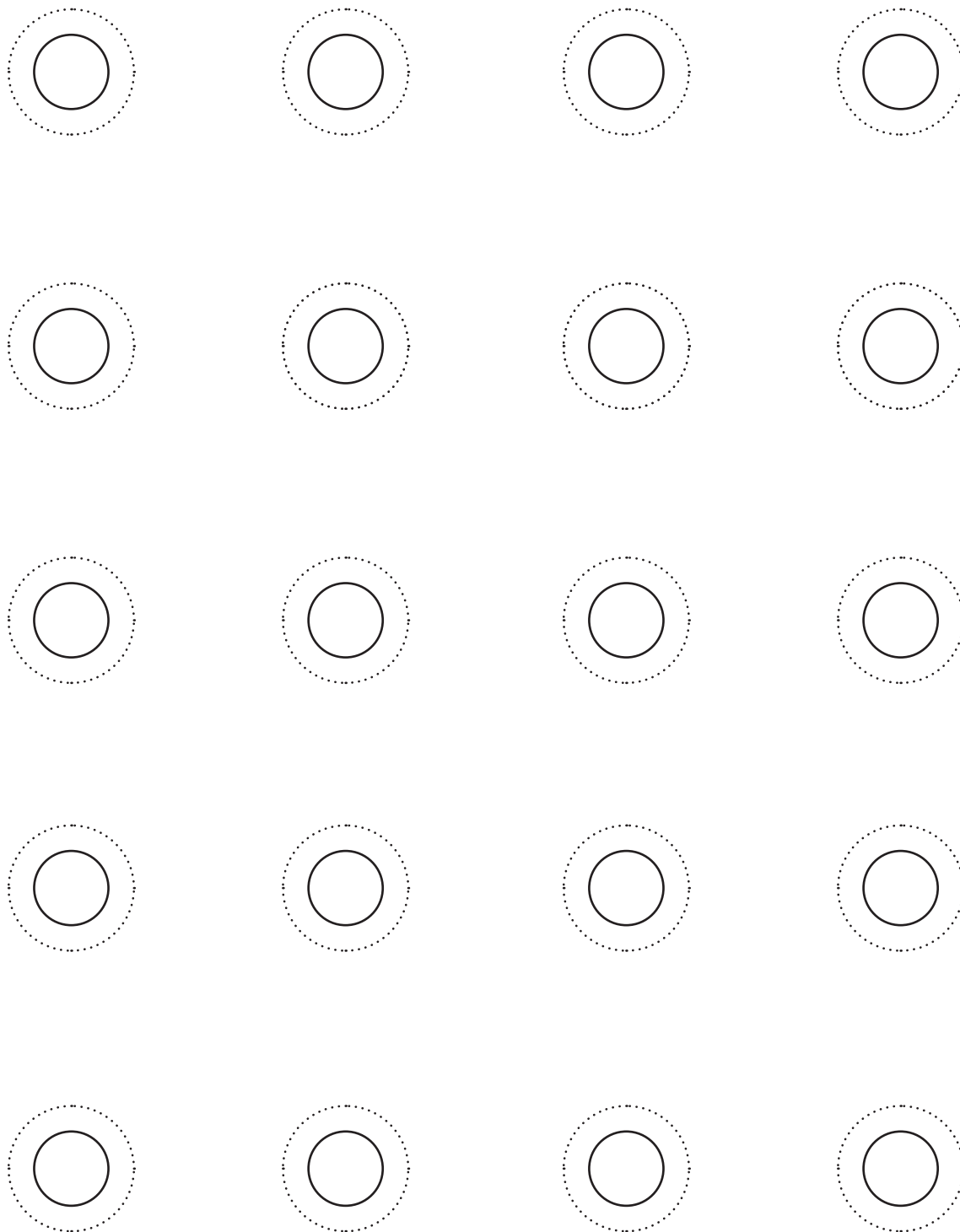
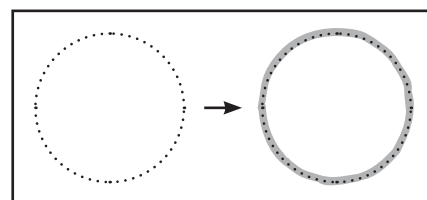

Sledi pikčastim črtam in riši kroge.

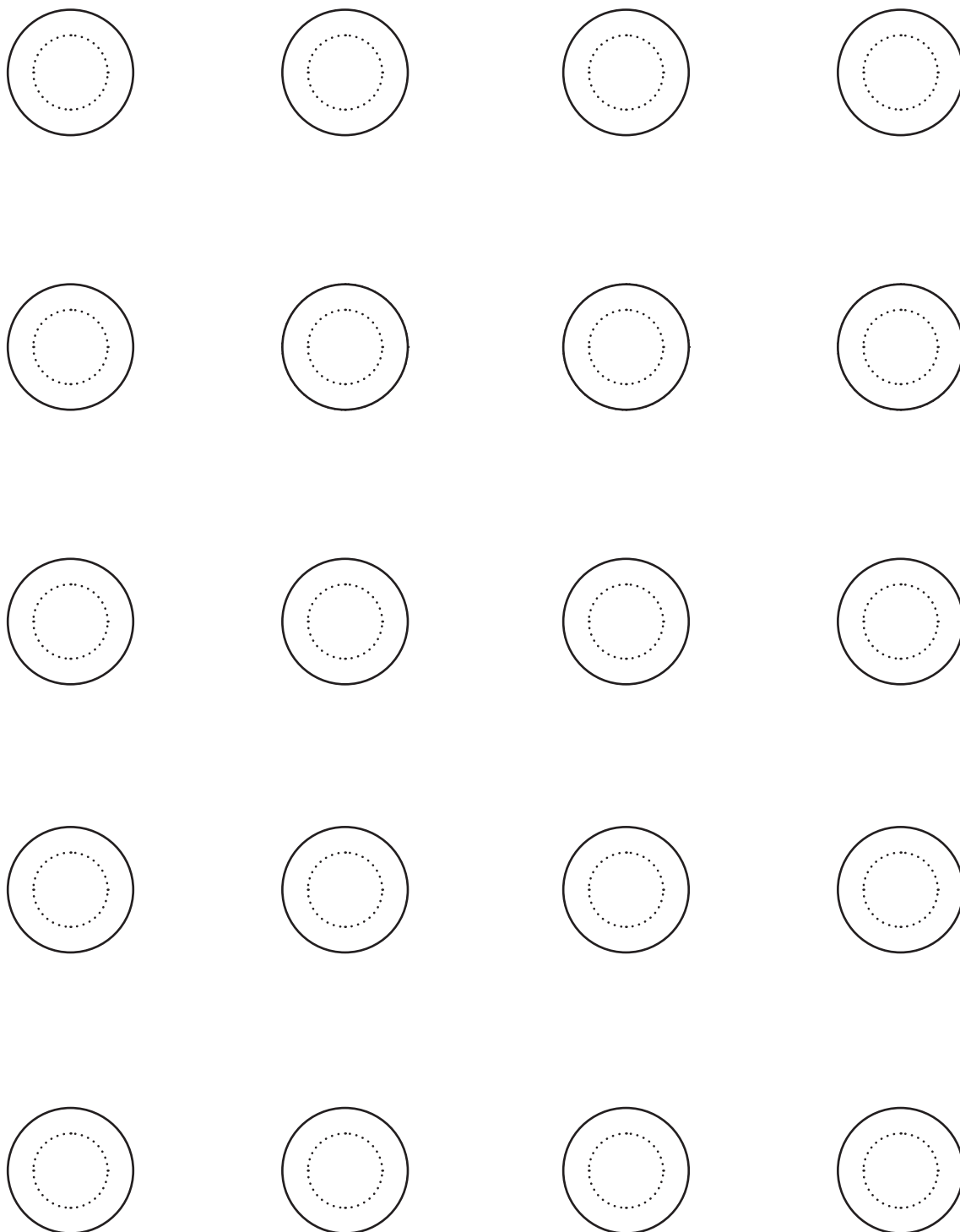
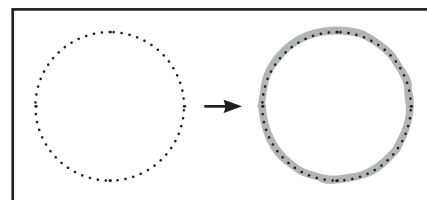

Sledi pikčastim črtam in riši kroge.

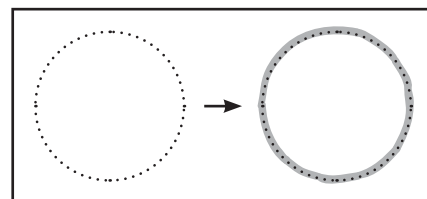

Sledi pikčastim črtam in riši kroge.

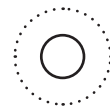
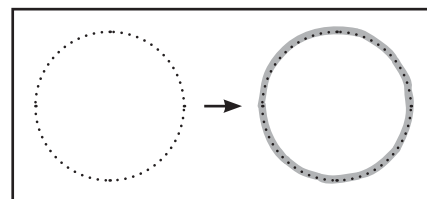

Sledi pikčastim črtam in riši kroge.

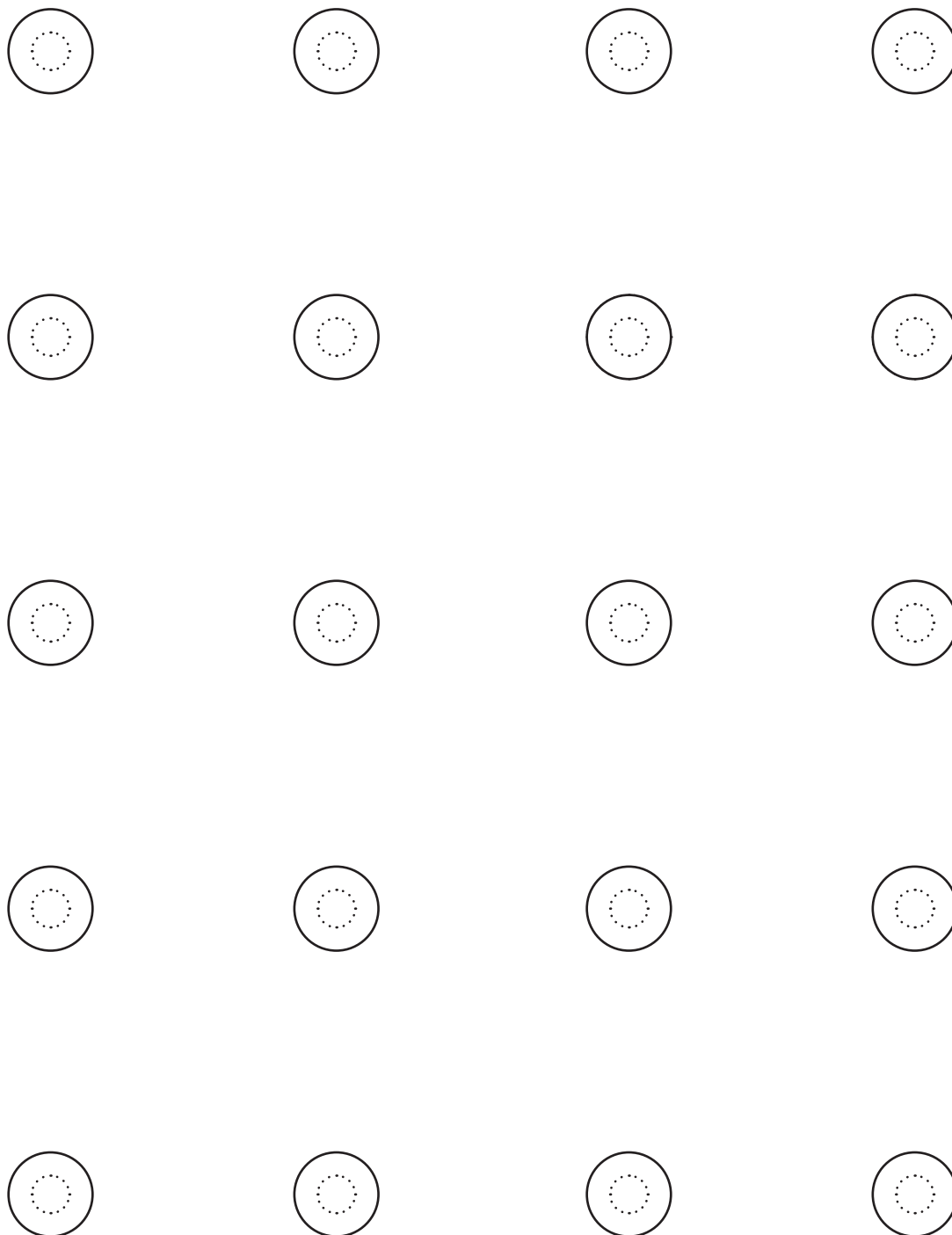
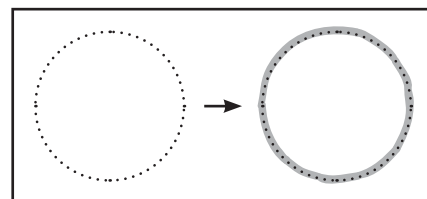

Sledi pikčastim črtam in riši kroge.

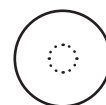
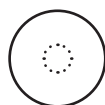
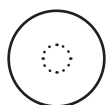
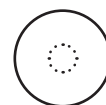
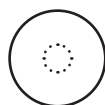
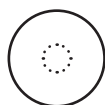
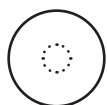
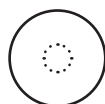
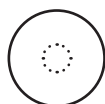
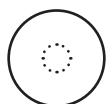
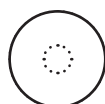
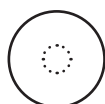
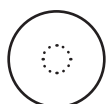
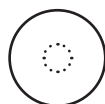
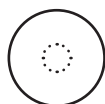
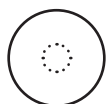
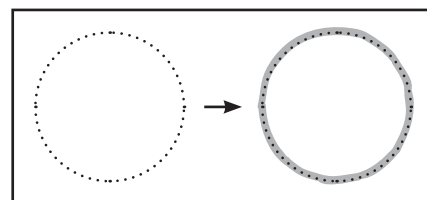

Sledi pikčastim črtam in riši kroge.

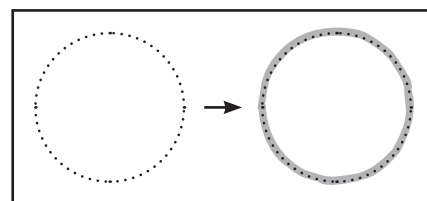

Sledi pikčastim črtam in riši kroge.

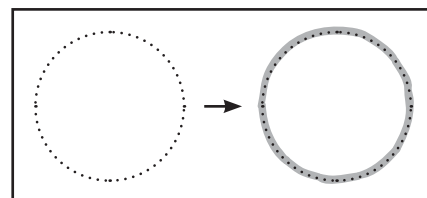

Sledi pikčastim črtam in riši kroge.

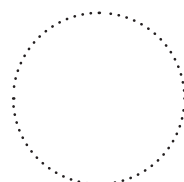
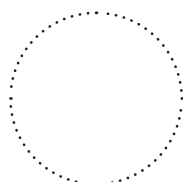
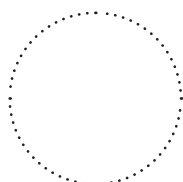
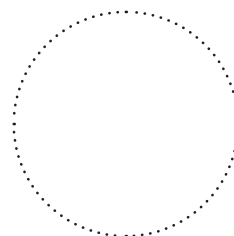
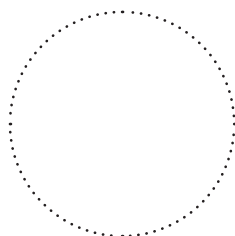
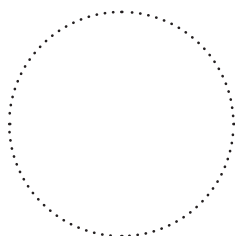
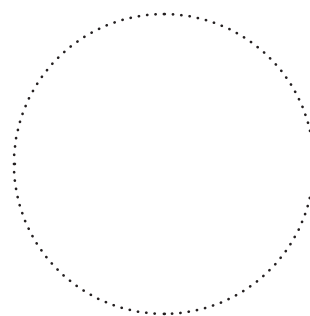
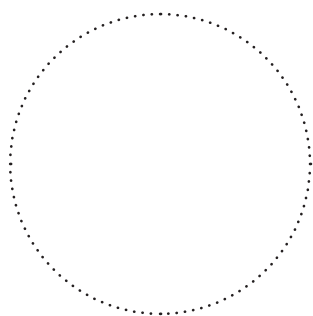
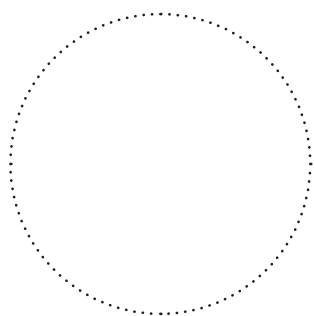
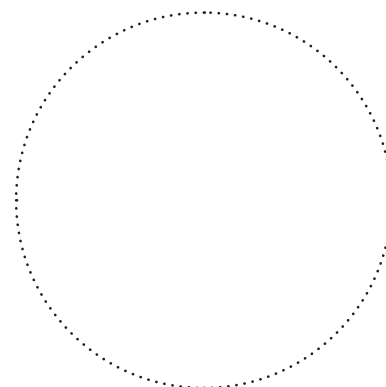
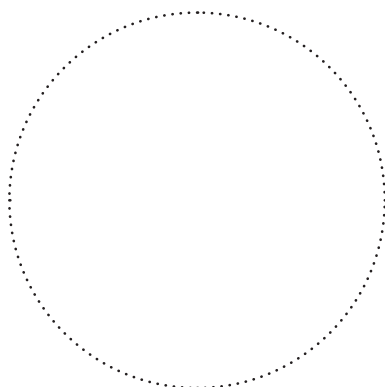
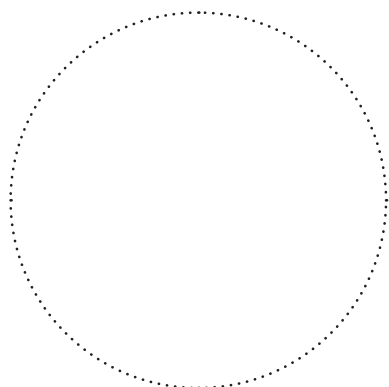
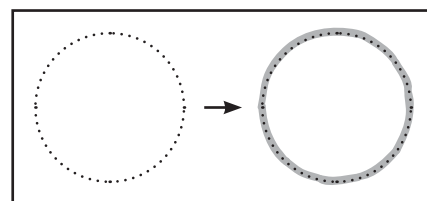

Sledi pikčastim črtam in riši kroge.

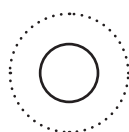
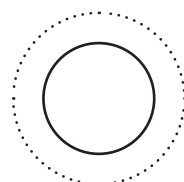
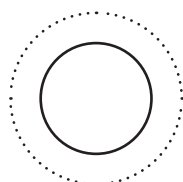
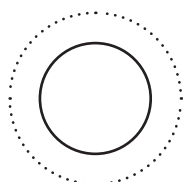
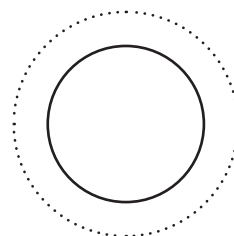
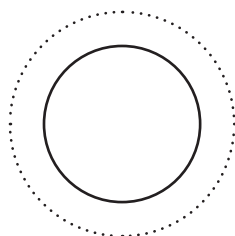
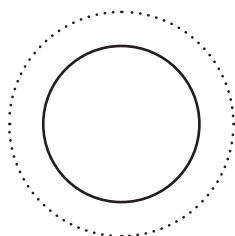
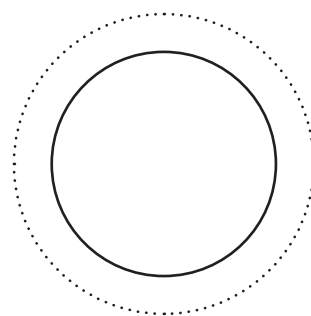
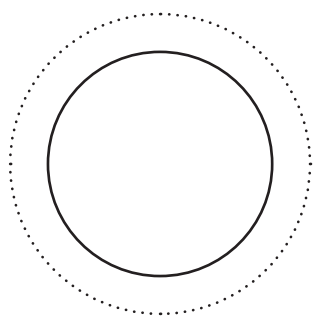
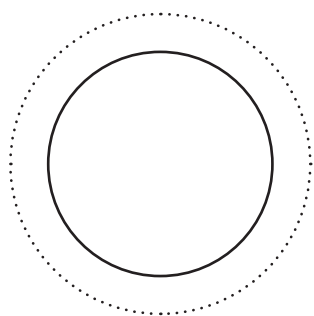
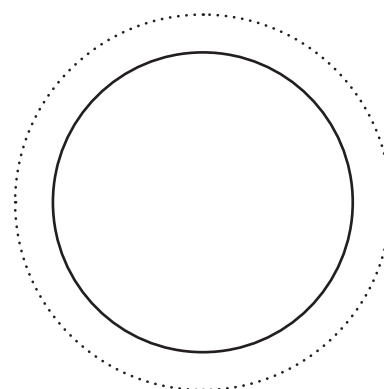
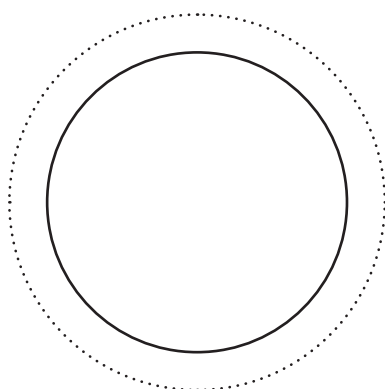
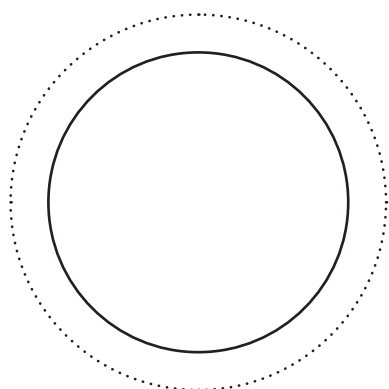
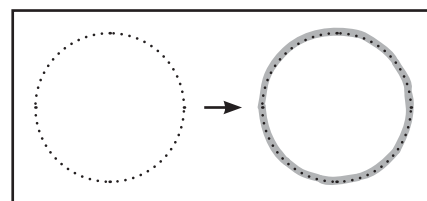

Sledi pikčastim črtam in riši kroge.

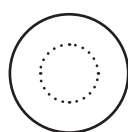
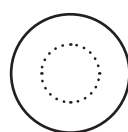
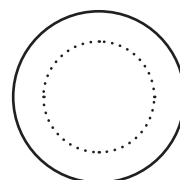
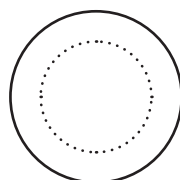
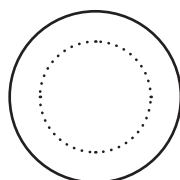
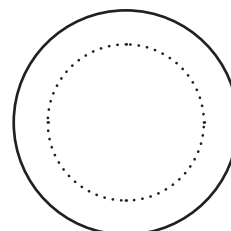
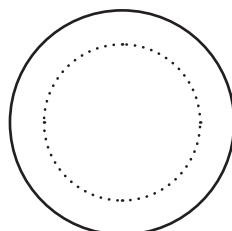
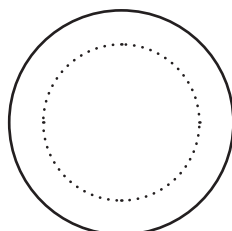
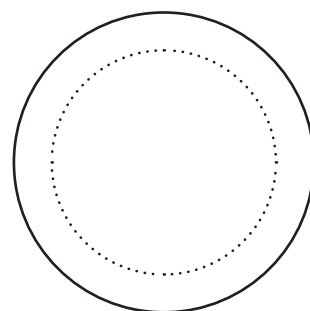
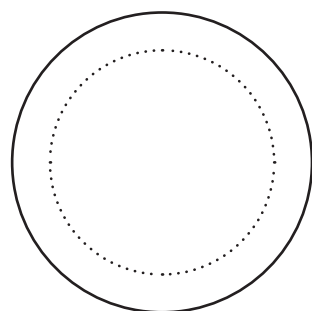
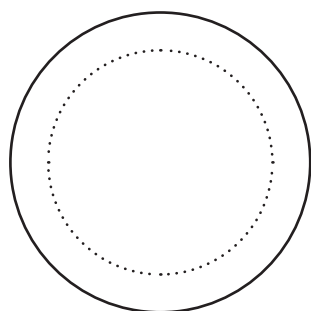
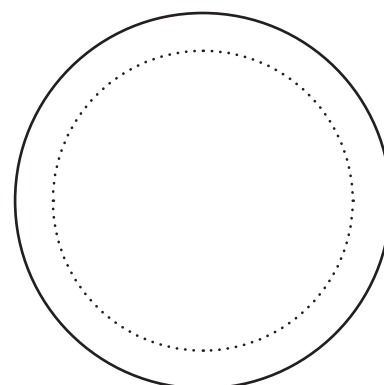
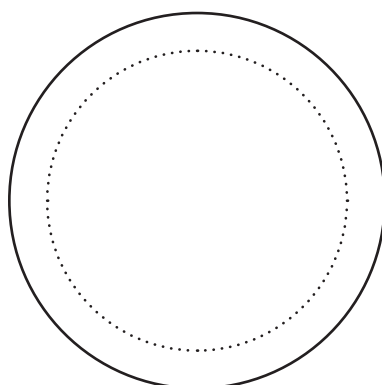
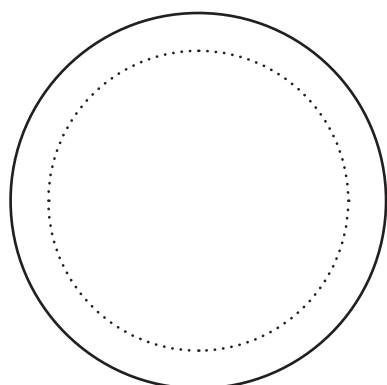
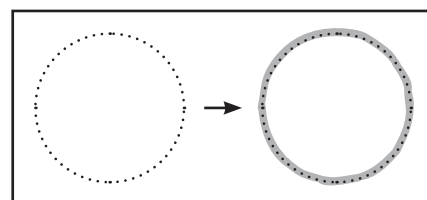

Sledi pikčastim črtam in riši kroge.

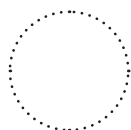
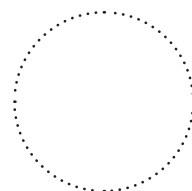
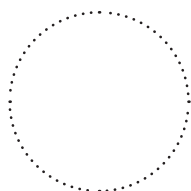
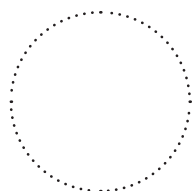
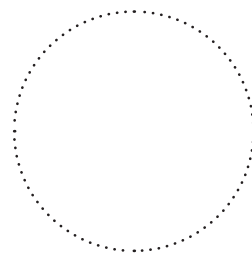
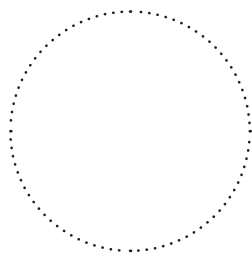
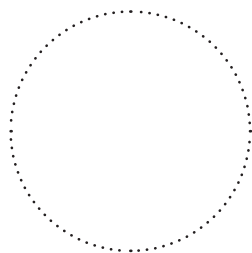
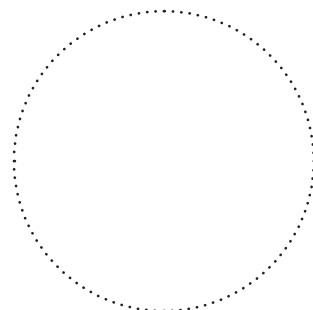
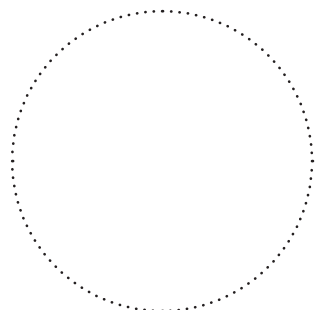
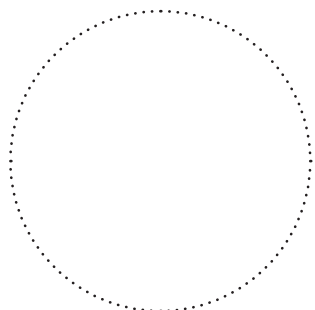
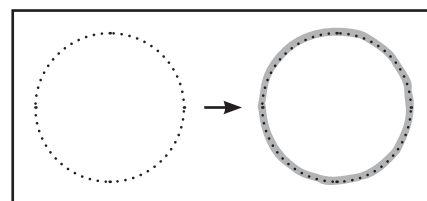

Sledi pikčastim črtam in riši kroge.

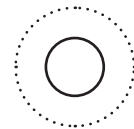
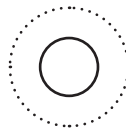
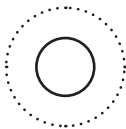
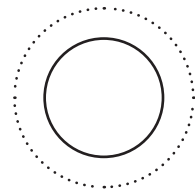
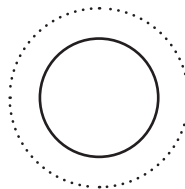
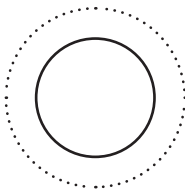
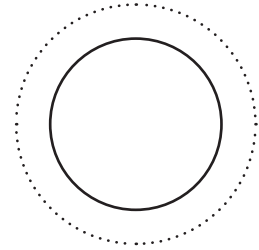
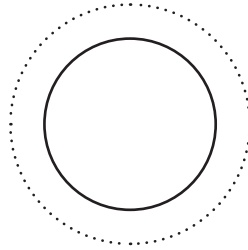
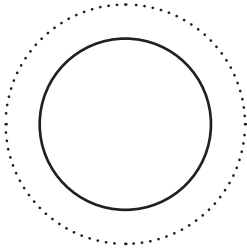
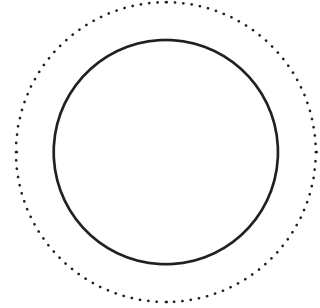
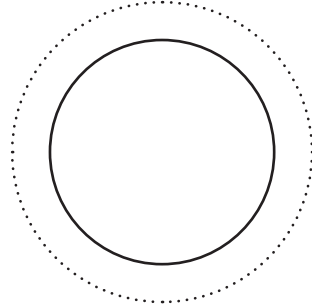
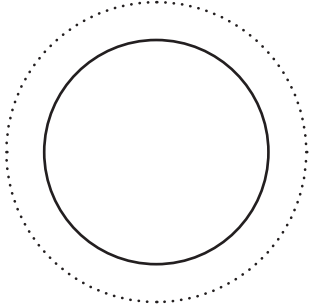
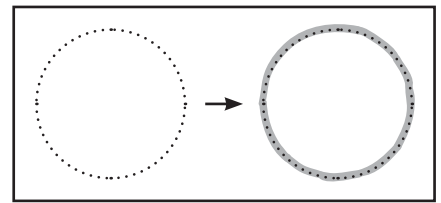

Sledi pikčastim črtam in riši kroge.

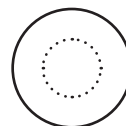
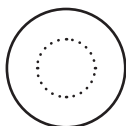
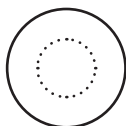
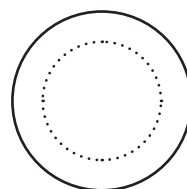
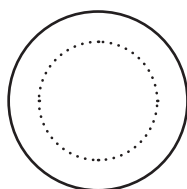
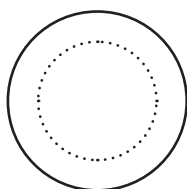
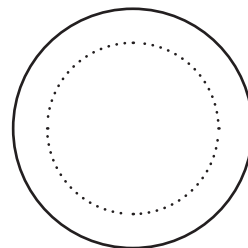
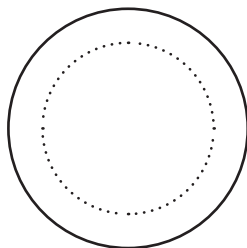
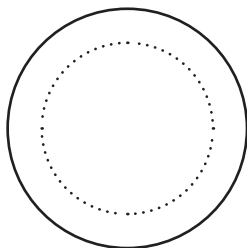
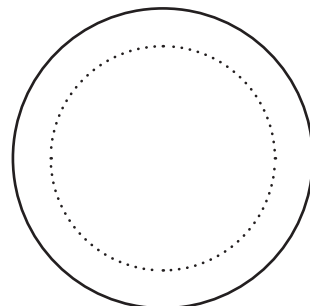
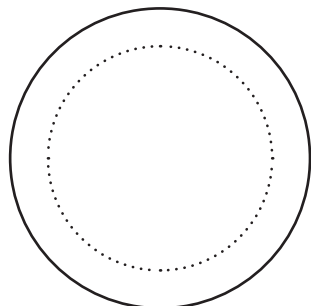
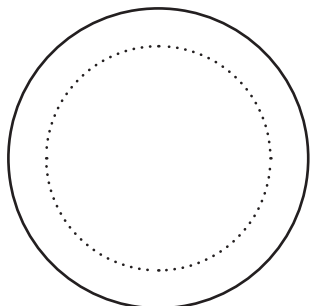
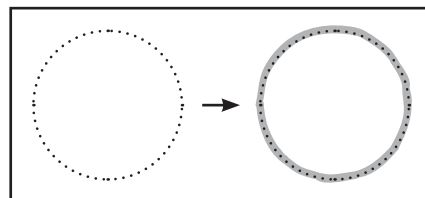

Sledi pikčastim črtam in riši kroge.

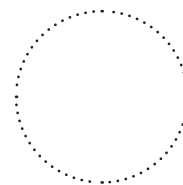
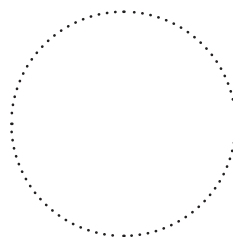
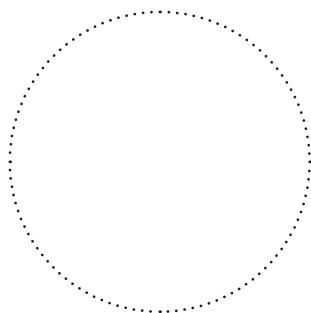
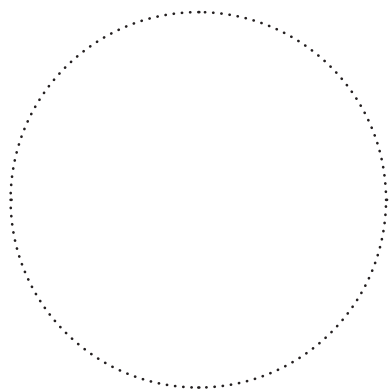
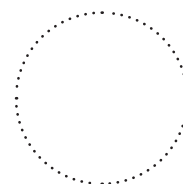
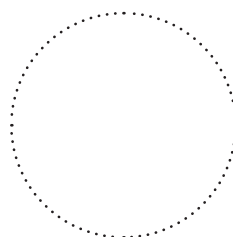
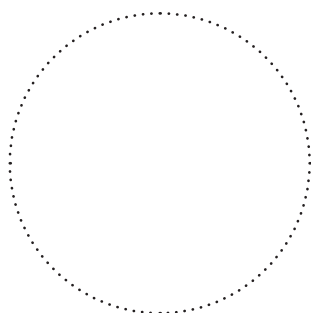
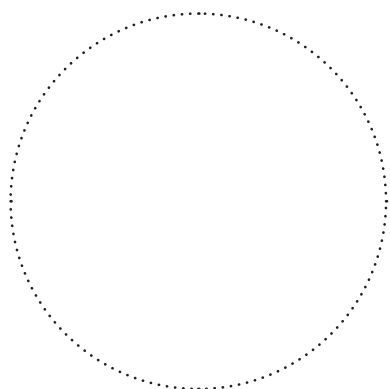
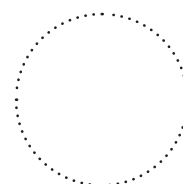
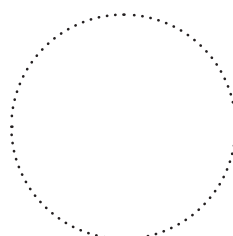
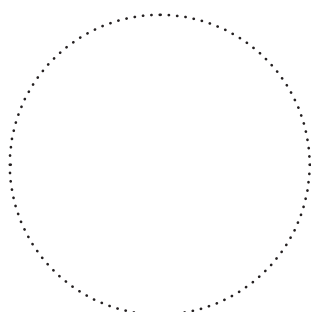
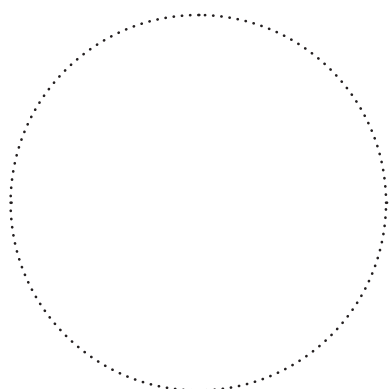
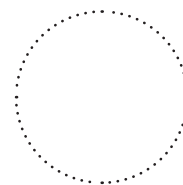
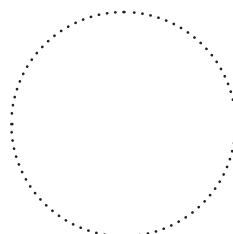
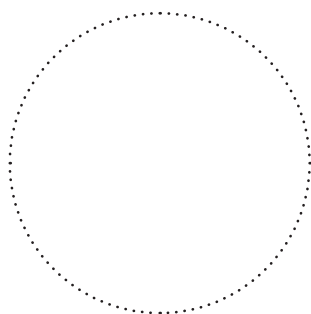
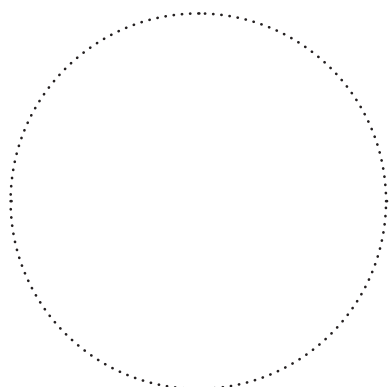
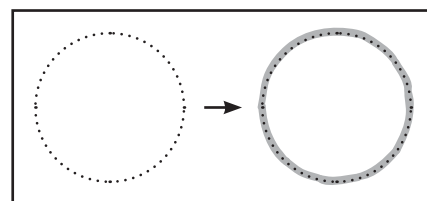

Sledi pikčastim črtam in riši kroge.

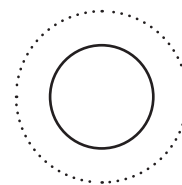
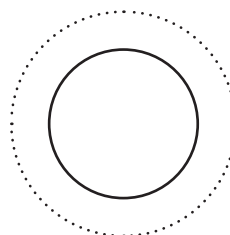
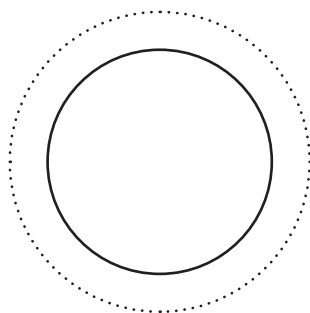
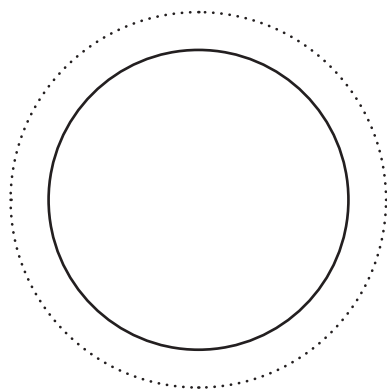
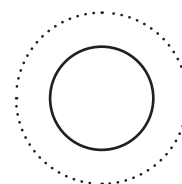
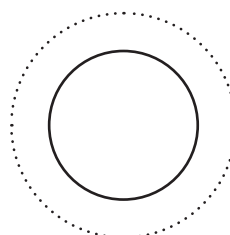
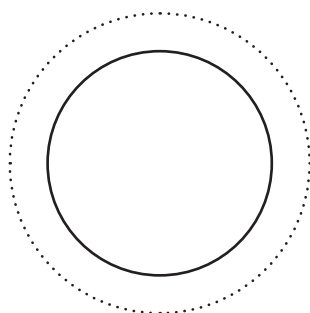
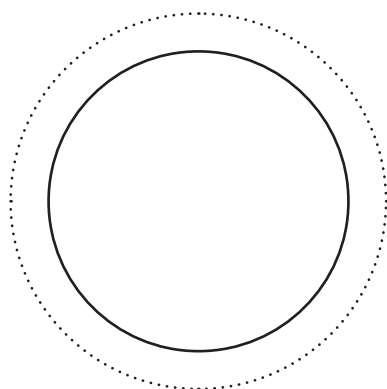
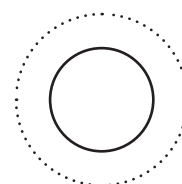
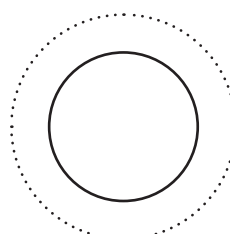
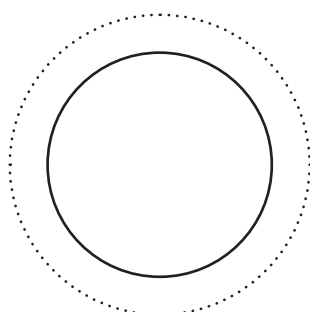
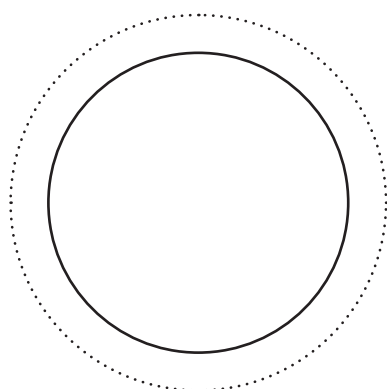
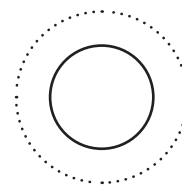
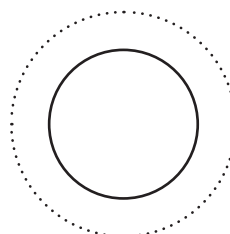
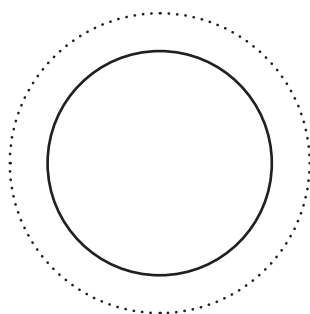
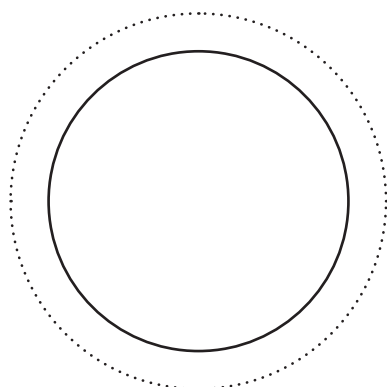
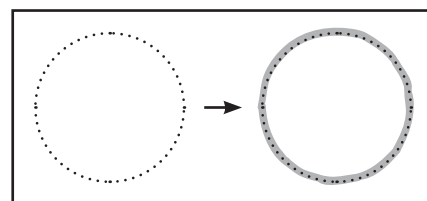

Sledi pikčastim črtam in riši kroge.

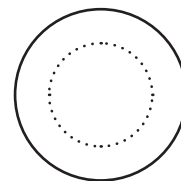
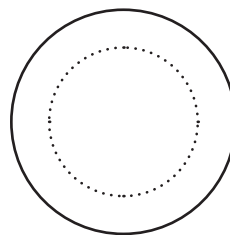
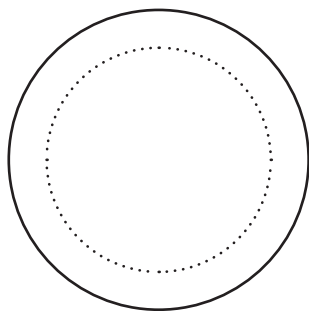
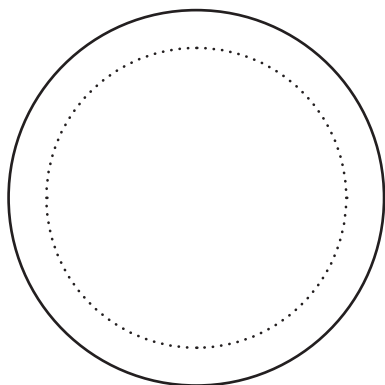
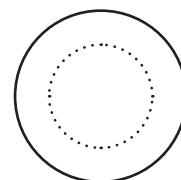
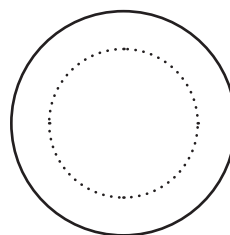
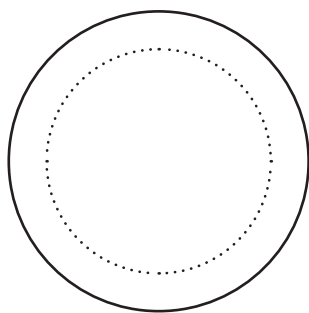
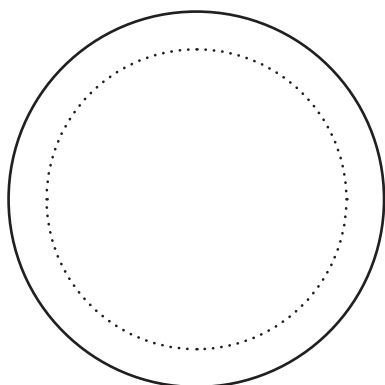
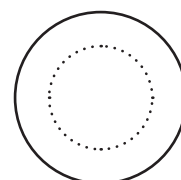
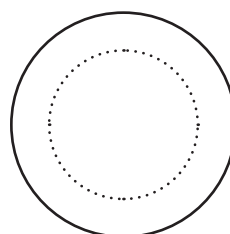
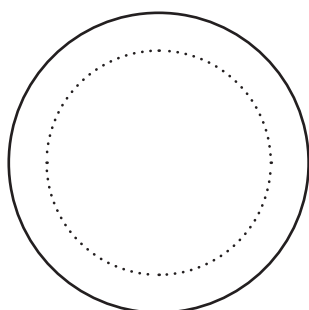
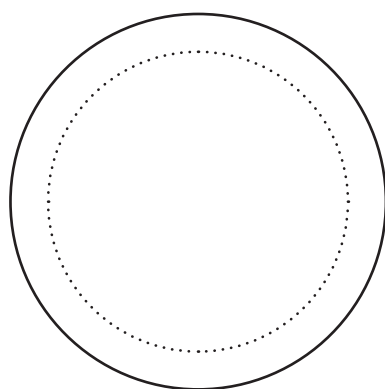
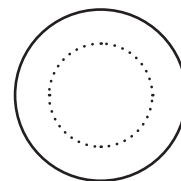
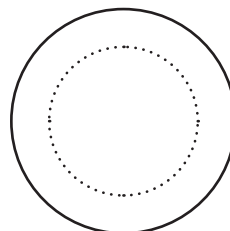
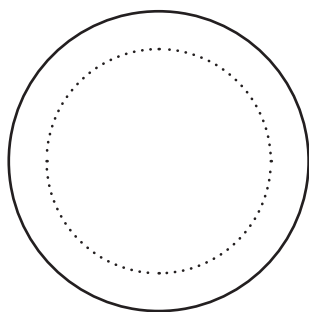
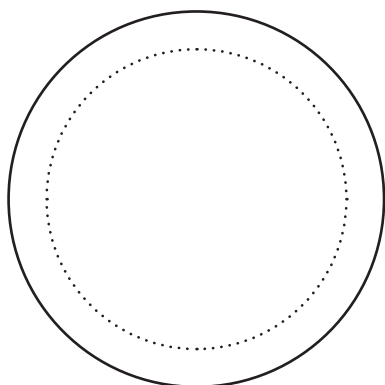
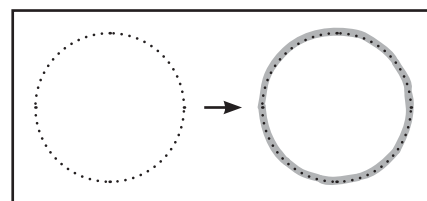

Sledi pikčastim črtam in riši kroge.

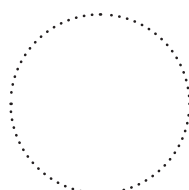
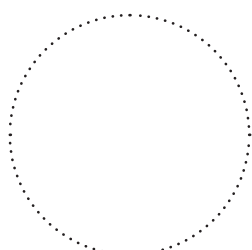
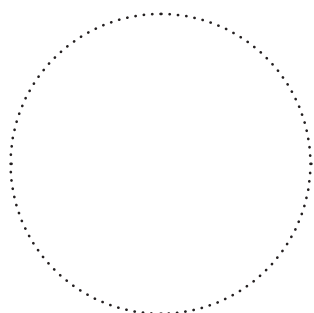
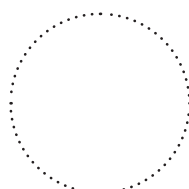
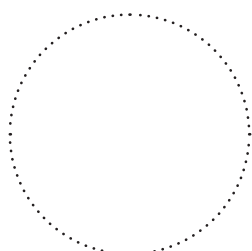
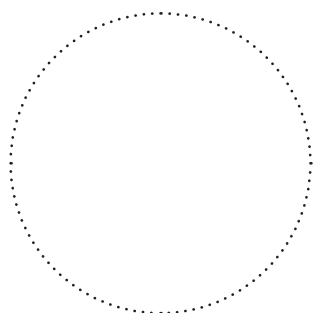
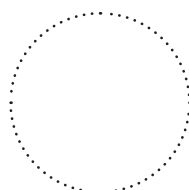
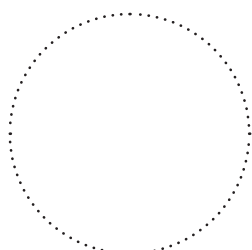
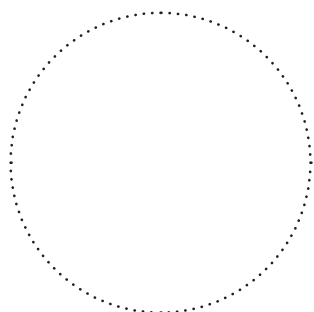
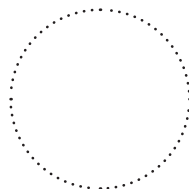
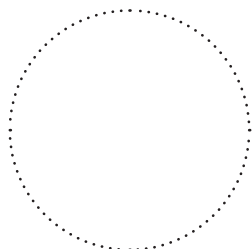
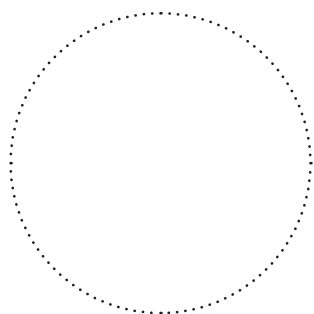
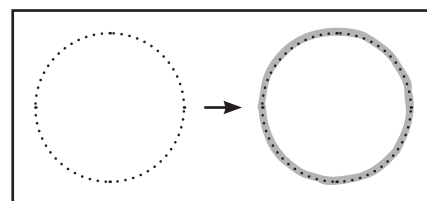

Sledi pikčastim črtam in riši kroge.

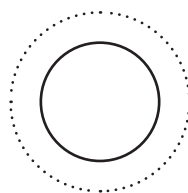
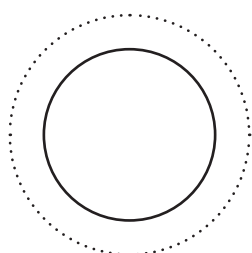
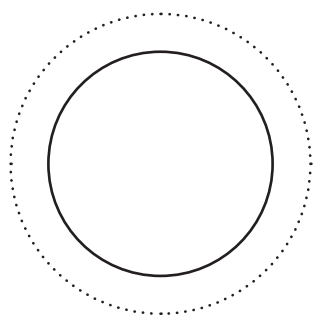
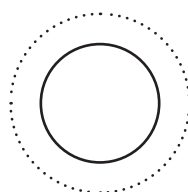
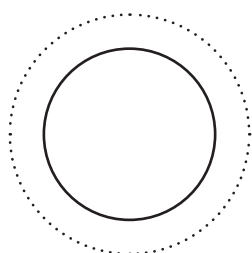
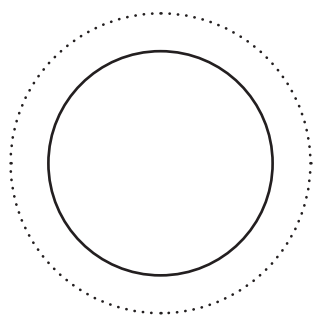
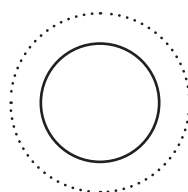
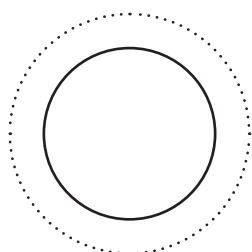
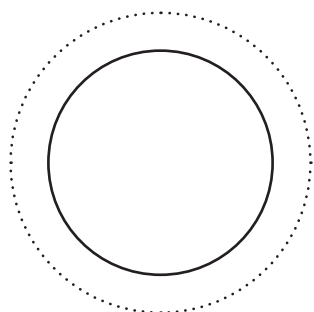
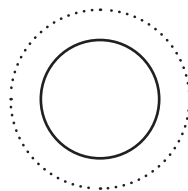
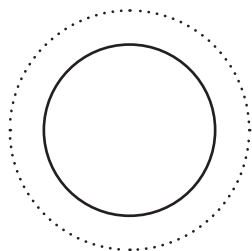
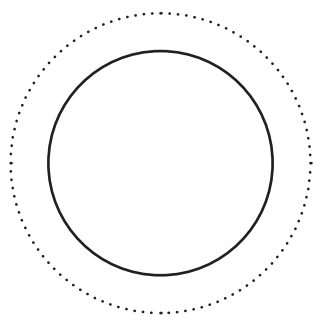
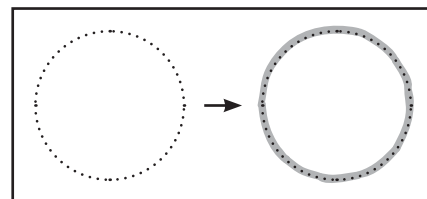

Sledi pikčastim črtam in riši kroge.

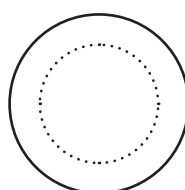
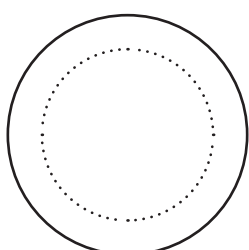
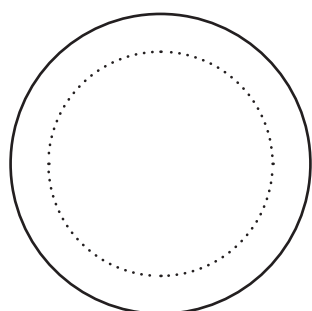
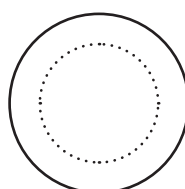
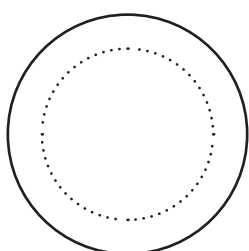
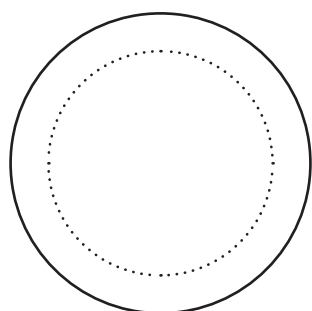
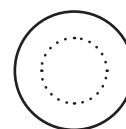
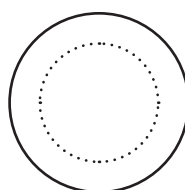
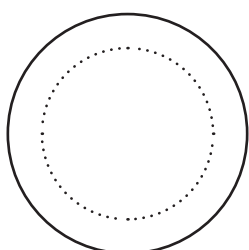
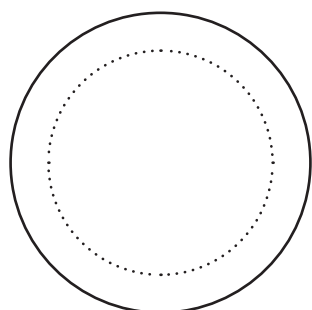
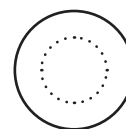
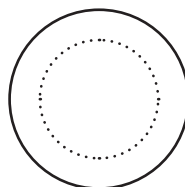
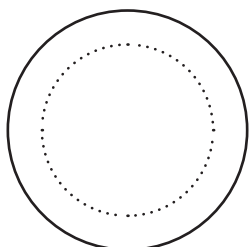
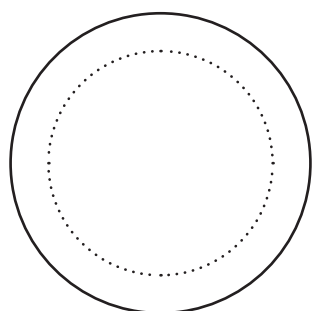
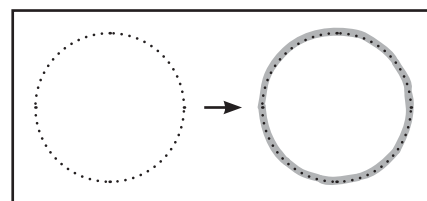

Sledi pikčastim črtam in riši kroge.

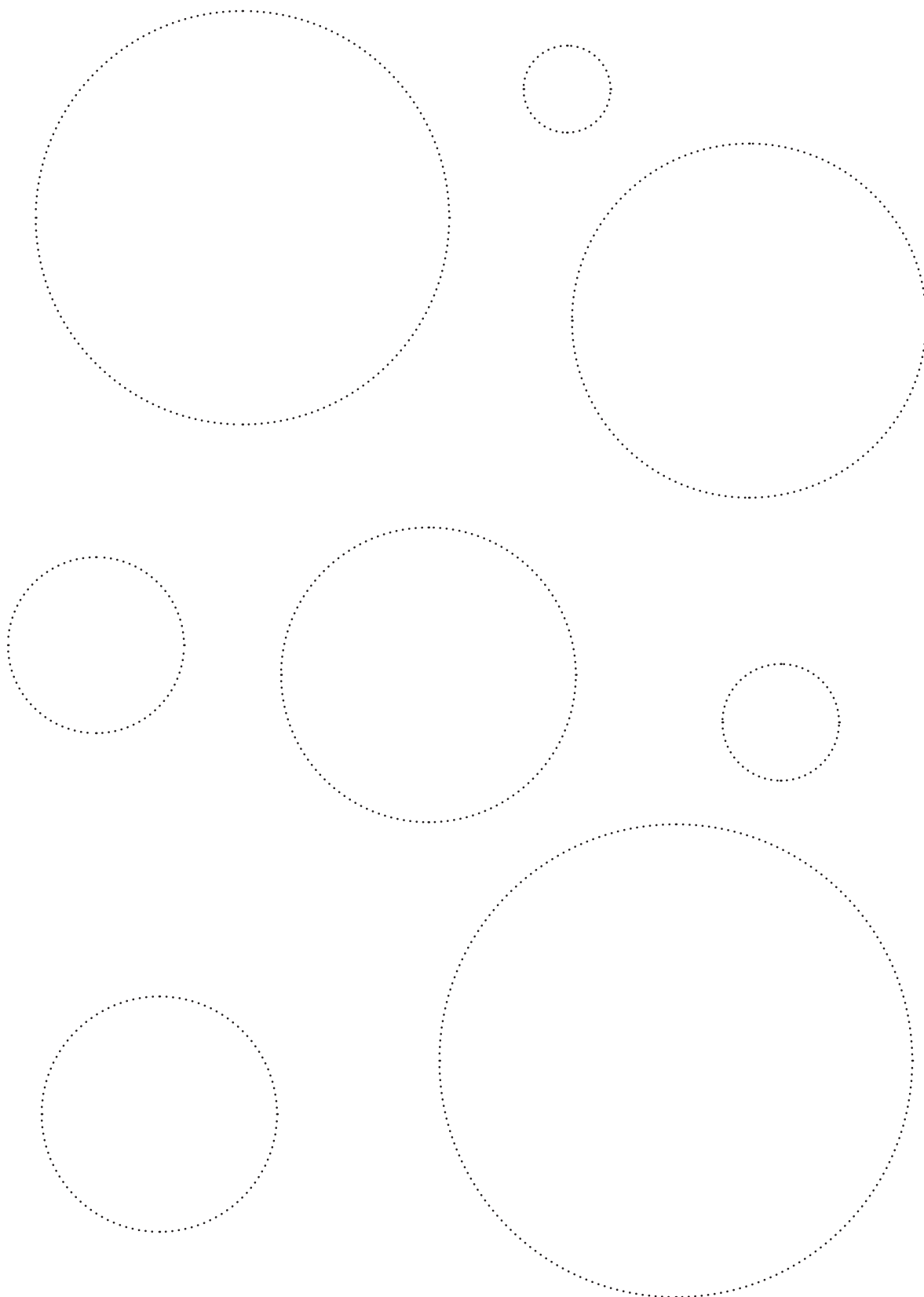
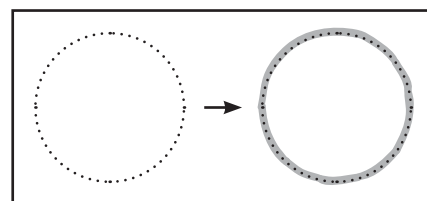

Sledi pikčastim črtam in riši kroge.

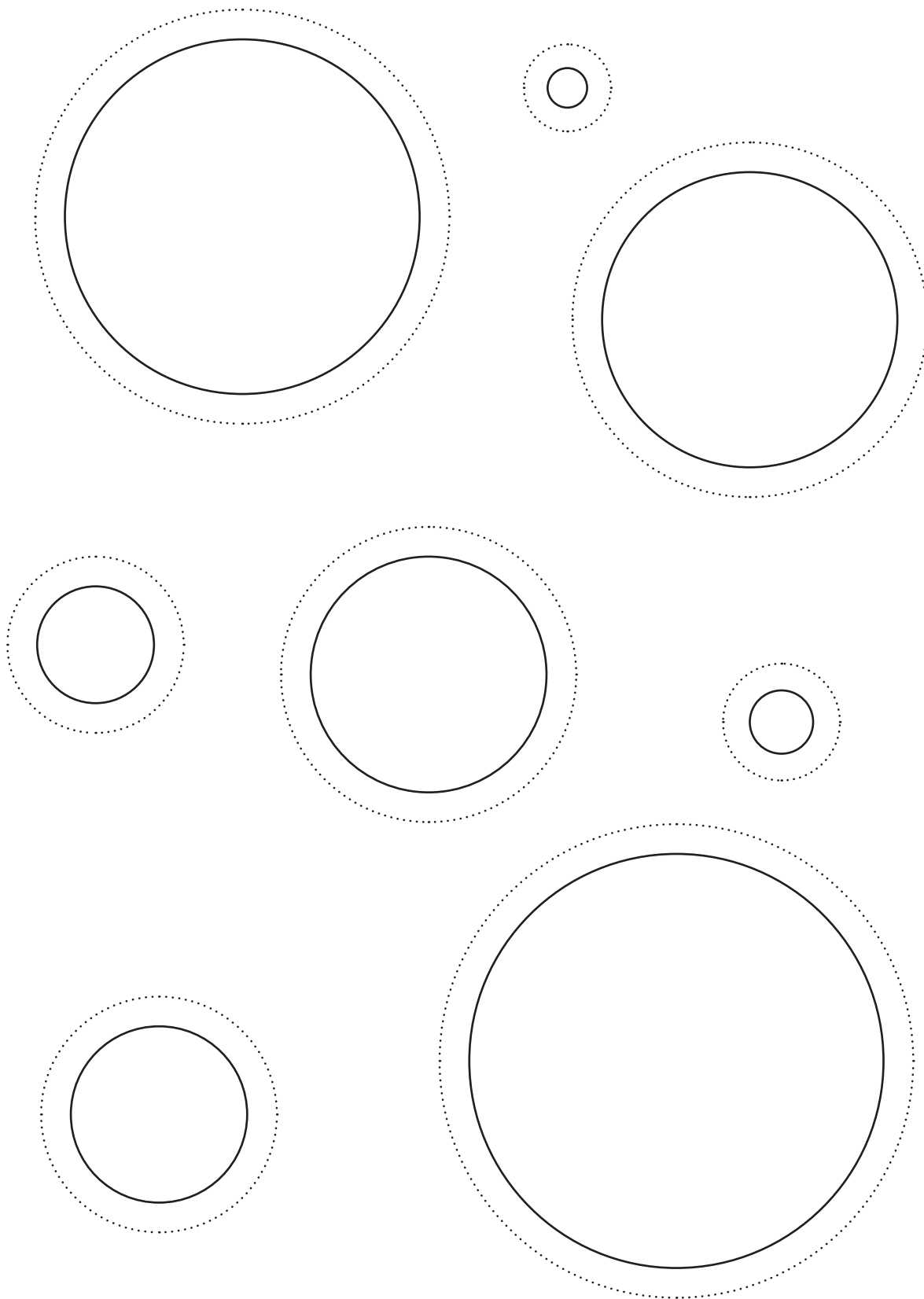
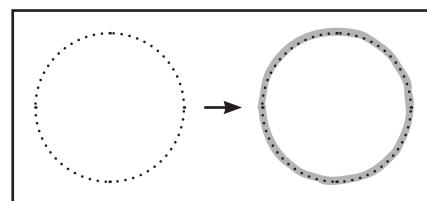

Sledi pikčastim črtam in riši kroge.

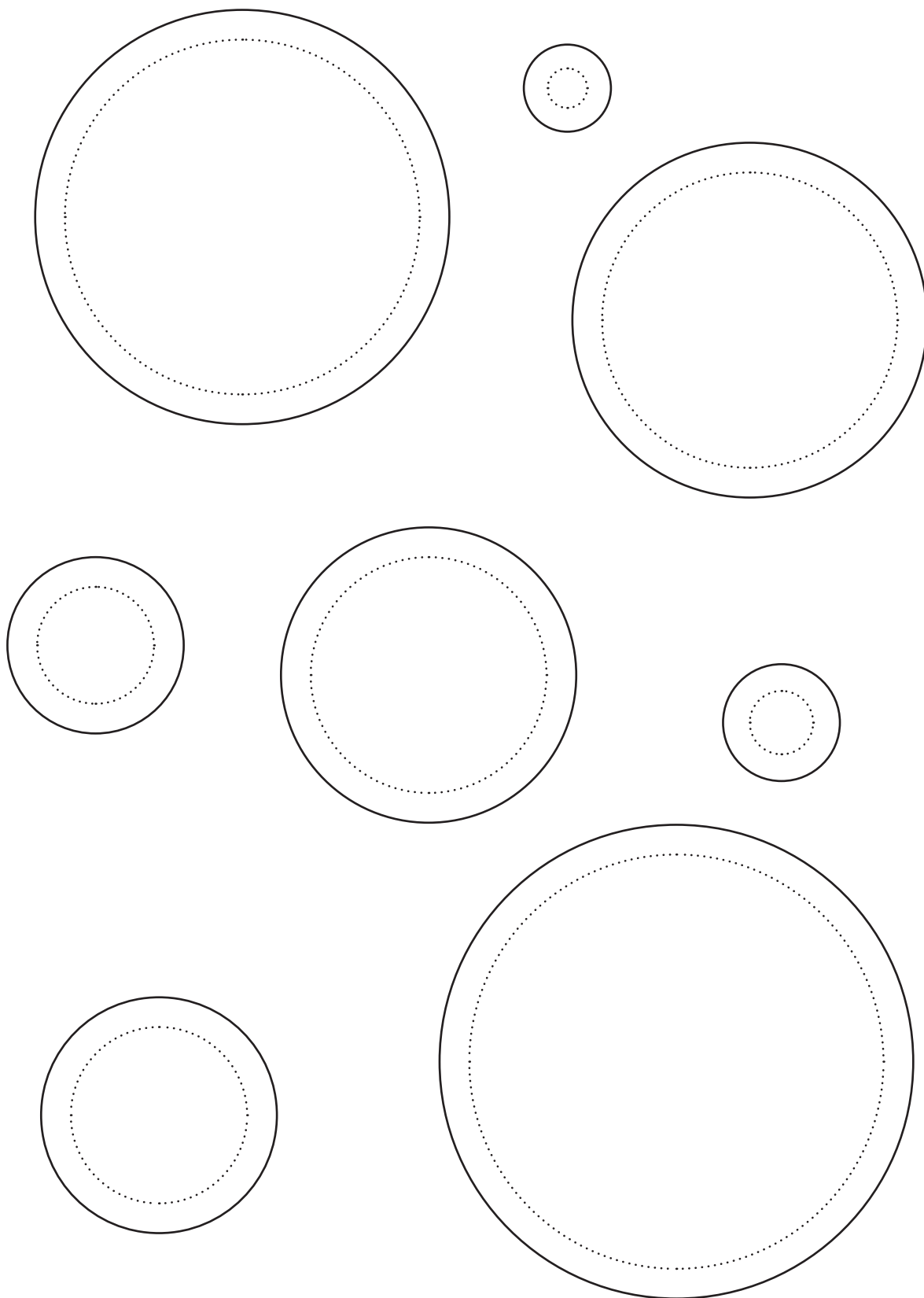
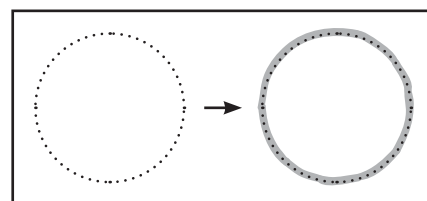

Sledi pikčastim črtam in riši kroge.

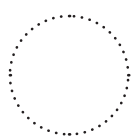
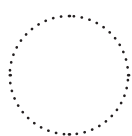
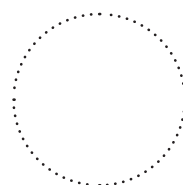
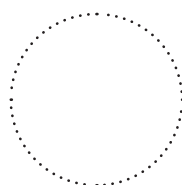
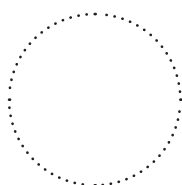
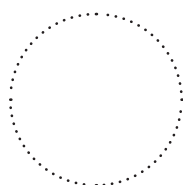
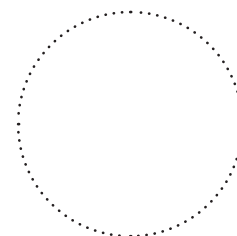
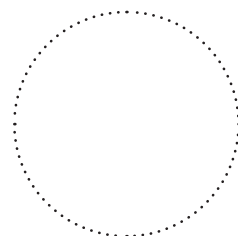
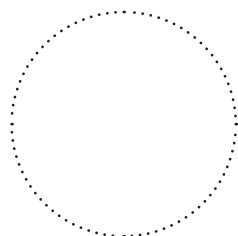
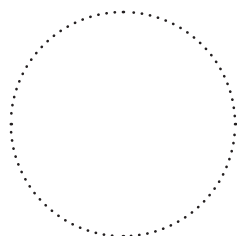
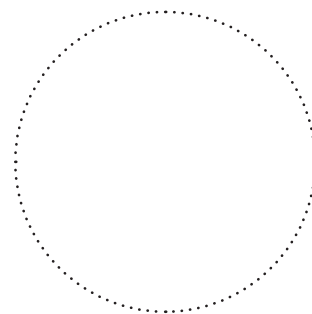
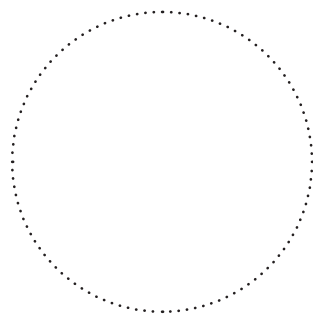
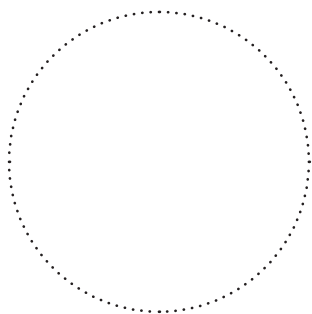
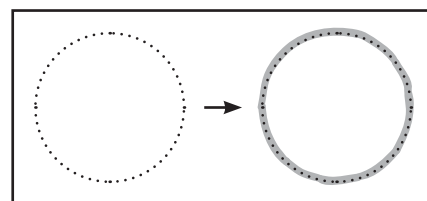

Sledi pikčastim črtam in riši kroge.

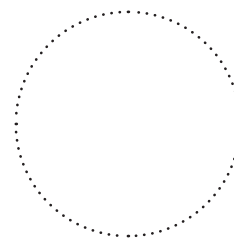
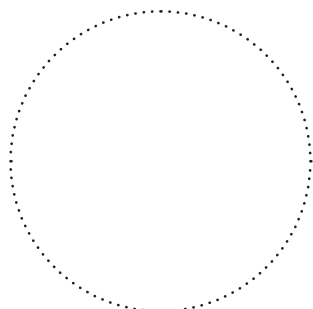
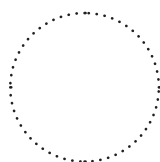
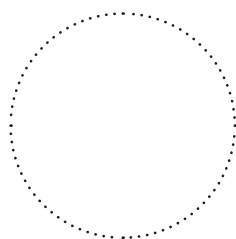
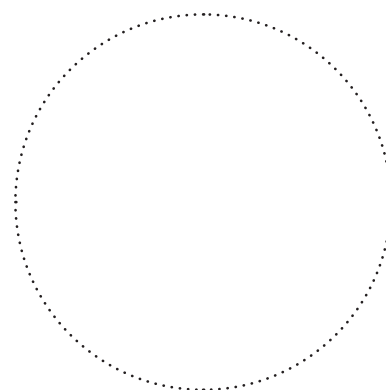
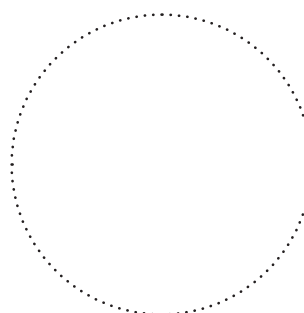
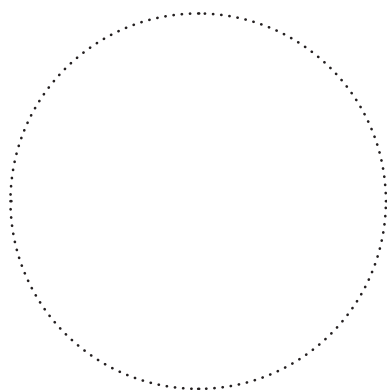
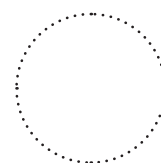
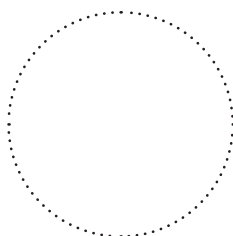
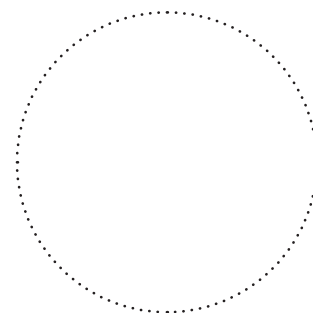
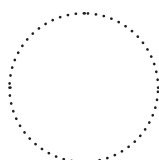
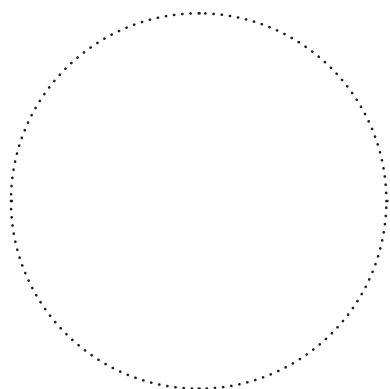
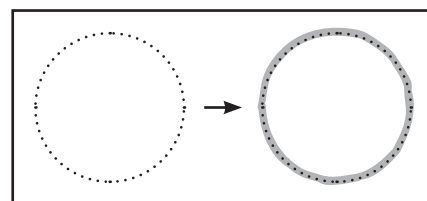

Sledi pikčastim črtam in riši kroge.

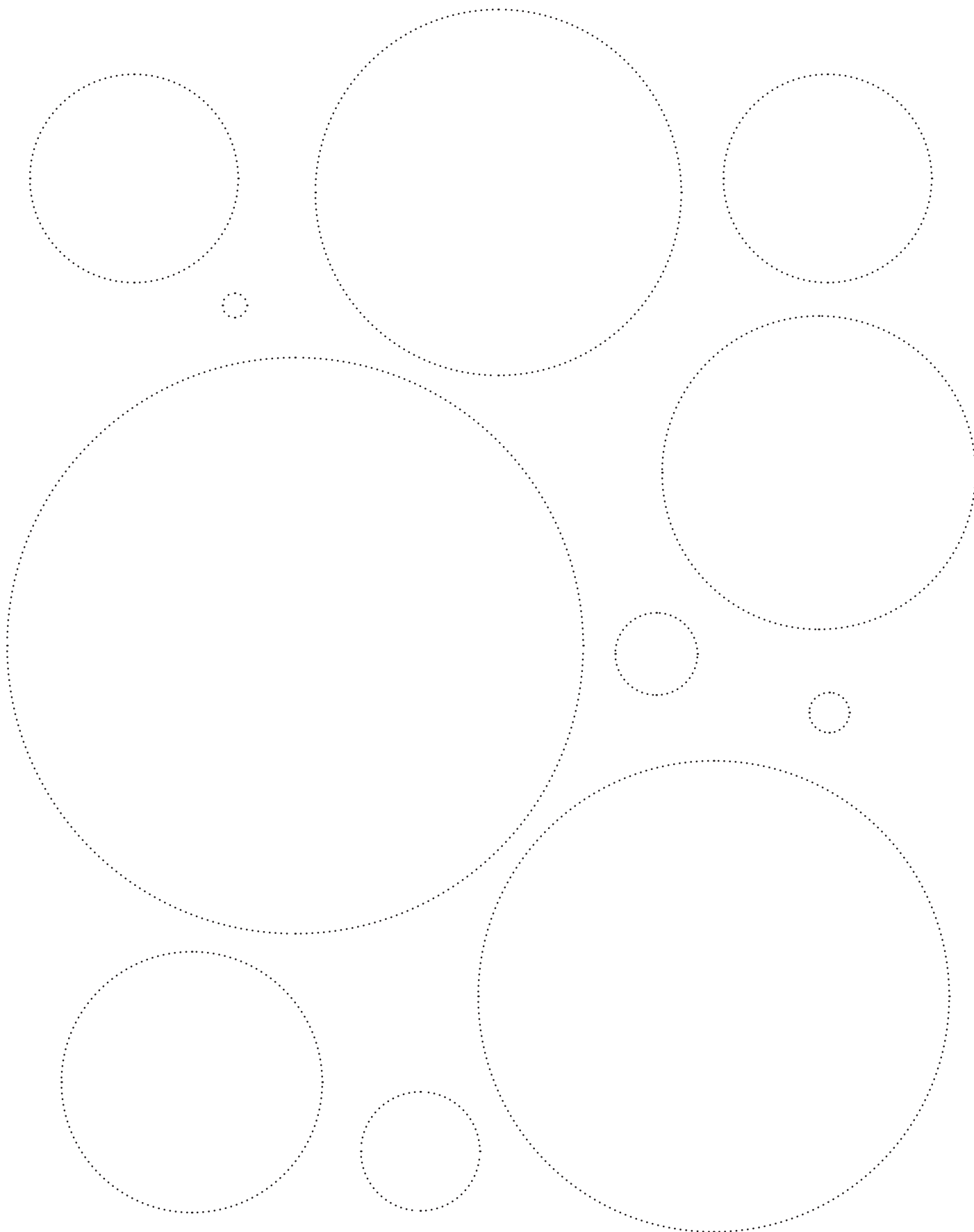
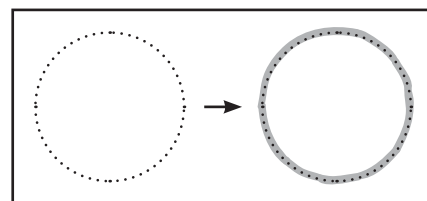

Sledi pikčastim črtam in riši kroge.

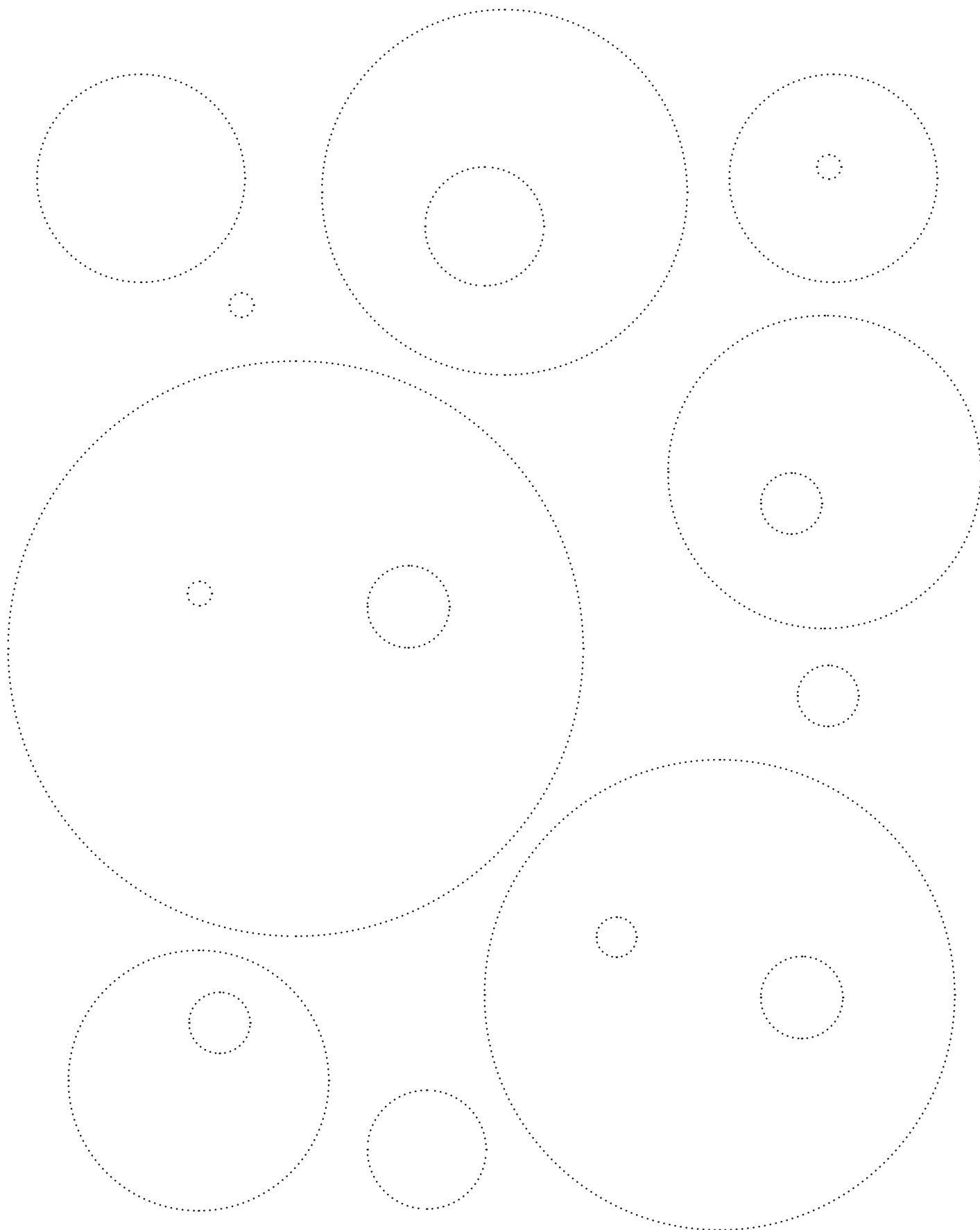
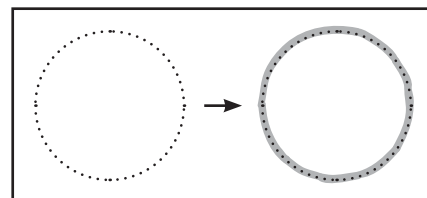

Sledi pikčastim črtam in riši kroge.

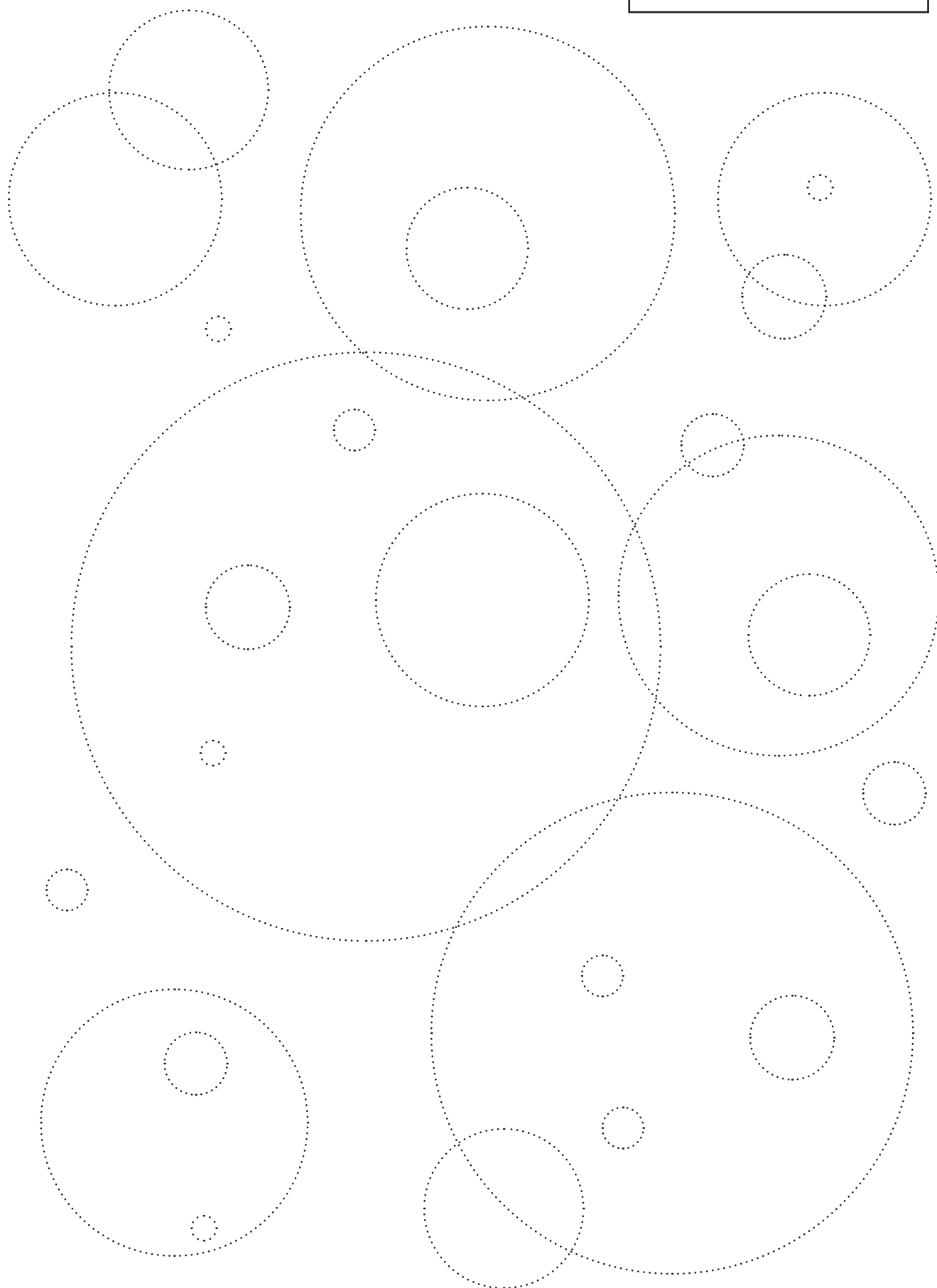
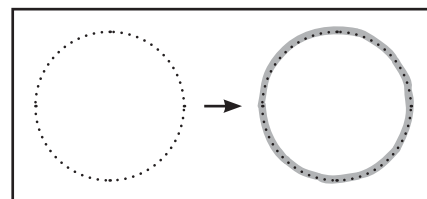

VIRI

- Beery, K.E. in Beery, N.A. (2004). *BeeryTM VMI Developmental Teaching Activities*. NCS Pearson Assessments: Minneapolis.
- Beery, K.E., Beery, N.A. in Evans, L. (2004a). *BeeryTM VMI My Book of Shapes with Instructor's Guide*. NCS Pearson Assessments: Minneapolis.
- Beery, K.E., Beery, N.A. in Evans, L. (2004b). *BeeryTM VMI My Book of Letters and Numbers with Instructor's Guide*. NCS Pearson Assessments: Minneapolis.
- Berninger, V.W. (2012, januar). Evidence-Based, Developmentally Appropriate Writing Skills K to 5: Teaching the Orthographic Loop of Working Memory to Write Letters So Developing Writers Can Spell Words, and Express Ideas. *Handwriting in the 21st century, Educational Summit*, Washington, D.C. Prosojnice dosežene na http://www.hw21summit.com/media/zb/hw21/H2937N_Berninger_presentation.pdf
- Brown, C.G. (2010). Improving fine motor skills in young children: an intervention study. *Educational Psychology in Practice*, 26(3), 269–278.
- Cameron, C.E., Brock, L.L., Murrah, W.M., Bell, L.H., Worzalla, S.L., Grissmer, D. in Morrison, F.J. (2012). Fine Motor Skills and Executive Function Both Contribute to Kindergarten Achievement. *Child Development*, 83(4), 1229–1244.
- Carlson, A.G., Rowe, E. in Curby, T.W. (2013). Disentangling Fine Motor Skills' Relations to Academic Achievement: The Relative Contributions of Visual-Spatial Integration and Visual-Motor Coordination. *Journal of Genetic Psychology*, 174(5), 514–533.
- Cirelli Copedde, A., Martins Okuda, P.M. in Aparecida Capellini, S. (2012). Performance of Children with Learning Difficulties in Fine Motor Function and Handwriting. *Journal of Human Growth and Development*, 22(3), 297–306.
- Curby, T.W. in Carlson, A.G. (2014). Fine Motor Skills and Academic Achievement. *Psychology Today*, 5. februar 2013.
- Davis, E. E., Pitchford, N. J. in Limback, E. (2011). The interrelation between cognitive and motor development in typically developing children aged 4–11 years is underpinned by visual processing and fine manual control. *British Journal of Psychology*, 102, 569–584.
- Dinehart, L. in Manfra, L. (2013). Associations between low-income children's fine motor skills in preschool and academic performance in second grade. *Early Education and Development*, 24, 138–161.
- Eisenstat, Z.M. (2006). *Improving visio-motor coordination in non-dominant hands through tracing tasks*. DSpace@MIT: Massachusetts Institute of Technology.
- Fahimi, M., Aslankhani, M.A., Shojaee, M., Beni, M.A. in Gholhaki, M.R. (2013). The Effect of Four Motor Pro-grams on Motor Proficiency in 7-9 Years Old Boys. *Middle-East Journal of Scientific Research*, 13(11), 1526–1532.
- Golos, A., Sarid, M., Weill, M. in Weintraub, N. (2011). Efficacy of an early intervention program for at-risk preschool boys: A two-group control study. *American Journal of Occupational Therapy*, 65, 400–408.
- Grissmer, D., Grimm, K.J., Aiyer, S.M., Murrah, W.H. in Steele, J.S. (2010). Fine Motor Skills and Early Comprehension of the World: Two New School Readiness Indicators. *Developmental Psychology*, 46 (5), 1008–1017.
- Grissmer, D.W., Mashburn, A.J., Cottone, E., Chen, W.B., Brock, L.L., Murrah, W.M. in Cameron, C.E. (2013). Play-based after-school curriculum improves measures of executive function, visuospatial and math skills and classroom behavior for high risk K-1 children. Predstavljeno na konferenci *Society for Research in Child Development*, Seattle, WA.
- Gunderson, E.A., Ramirez, G., Beilock, S.L. in Levine, S. C. (2012). The Relation Between Spatial Skill and Early Number Knowledge: The Role of the Linear Number Line. *Developmental Psychology*. 48(5), 1229–1241.
- Hamm, E.M. in Harper, K.A. (2014). The Role of RtI in a Kindergarten Enrichment Program. *Reading and Writing Quarterly*, 30(1), 32–50.
- Kambas, A., Fatouros, Y., Christoforidis, C., Venetsanou, F., Papageorgiou, P., Giannakidou, D. in Aggeloussis, N. (2010). The effects of Psychomotor Intervention, on Visual-Motor Control as a Graphomotor aspect in preschool age. *European Psychomotoricity Journal*, 3(1), 54–61.
- Keller, M. (2001). Handwriting Club: Using Sensory Integration Strategies To Improve Handwriting. *Intervention in School and Clinic*, 37(1), 9–12.
- Lahav, O., Apter, A. in Ratzon, N.Z. (2013). Psychological adjustment and levels of self esteem in children with visual-motor integration difficulties influences the results of a randomized intervention trial. *Research in Developmental Disabilities*, 34, 56–64.
- Landy, J. M. in Burrige, K. R. (1999). *Ready-to-Use Fine Motor Skills and Handwriting Activities for Young Children: Teaching, Remediation and Assessment*. Upper Saddle River, NJ: Pearson Education.

- Luo, Z., Jose, P.E., Huntsiger, C.S in Pigott, T.D. (2007). Fine motor skills and mathematics achievement in East Asian American and European American kindergartners and first graders. *British Journal of Developmental Psychology*, 25, 595–614.
- Morales, J., Gonzalez, L.M., Guerra, M., Virgili, C. in Unnithan, V. (2011). Physical activity, perceptual-motor performance, and academic learning in 9-to-16-years-old school children. *International Journal of Sport Psychology*, 42, 401-415.
- Murrah, W., Chen, W.B. in Cameron, C.E. (2013). Why do Fine Motor Skills Predict Mathematics? Construct Validity of the Design Copying Task. *The Society for Research on Educational Effectiveness Fall 2013 Conference*, Washington, D.C.
- Pagani, L.S., Fitzpatrick, C., Archambault, I. in Janosz, M. (2010). School Readiness and Later Achievement: A French Canadian Replication and Extension. *Developmental Psychology*, 46(5), 984–994.
- Pagani, L.S., Fitzpatrick, C., Belleau, L. in Janosz, M. (2011). *Predicting Academic Achievement in Fourth Grade from Kindergarten Cognitive, Behavioural and Motor Skills*. Québec Longitudinal Study of Child Development (QLSCD 1998-2010) – From Birth to 10 Years of Age, Québec, Institut de la statistique du Québec, Vol. 6, Fascicle 1.
- Pagani, L.S. in Massier, S. (2012). Links between Motor Skills and Indicators of School Readiness at Kindergarten Entry in Urban Disadvantaged Children. *Journal of Educational and Developmental Psychology*, 2(1), 95-107.
- Pereira D.M, Araújo R.C.T. in Braccialli L.M.P. (2011). Relationship analysis between visual-motor integration ability and academic performance. *Journal of Human Growth and Development*, 21(3), 808-817.
- Piek, J.P., Hands, B. in Licari, M.K. (2012). Assessment of Motor Functioning in the Preschool Period. *Neuropsychological Review*. Na spletu. doi: 10.1007/s11065-012-9211-4.
- Pontart V., Bidet-Ildei C., Lambert E., Morisset P., Flouret L. in Alamargot D. (2013). Influence of Handwriting Skills during Spelling in Primary and lower Secondary Grades. *Frontiers in Psychology*. Na spletu. doi:10.3389/fpsyg.2013.00818
- Ratzon N.Z., Efraim D in Bart O. (2007). A short-term graphomotor program for improving writing readiness skills of first-grade students. *American Journal of Occupational Therapy*, 61(4), 399-405.
- Roebers, C.M., Röthlisberger, M., Neuenschwander, R., Cimeli, P., Michel, E in Jäger, K. (2013). The relation between cognitive and motor performance and their relevance for children's transition to school: A latent variable approach. *Human Movement Science*. Na spletu: <http://dx.doi.org/10.1016/j.humov.2013.08.011>
- Sheridan, S.R. (2002). The Neurological Significance of Children's Drawing: The Scribble Hypothesis. *Journal of Visual Literacy*, 22(2), 107-128.
- Sortor, J.M. in Kulp, M.T. (2003). Are the results of the Beery–Buktenica Developmental Test of Visual-Motor Integration and its subtests related to achievement test scores? *Optometry and Vision Science*, 80(11), 758–763.
- Sparks, S.D. (2013). Studies Link Early Spatial Skills to Math Achievement. *Education week*, 15. maj 2013.
- St. John, S. (2013). Factoring in Fine Motor: How Improving Fine Motor Abilities Impacts Reading and Writing. *Illinois Reading Council Journal*, 41(4), 134-146.
- Stewart, R.A., Rule, A.C. in Giordano, D.A. (2007). The Effect of Fine Motor Skill Activities on Kindergarten Student Attention. *Early Childhood Education Journal*, 35(2), 103-109.
- Stoeger, H., Suggate, S. in Ziegler, A. (2013). Identifying the causes of underachievement: A plea for the inclusion of fine motor skills. *Psychological Test and Assessment Modeling*, 55 (3), 274-288.
- Stoeger, H. in Ziegler, A. (2010). How Fine Motor Skills Influence the Assessment of High Abilities and Underachievement in Math. *Journal for the Education of the Gifted*, 34(2), 195-219.
- Stoeger, H. in Ziegler, A. (2013). Deficits in Fine Motor Skills and Their Influence on Persistence among Gifted Elementary School Pupils. *Psychological Test and Assessment Modeling*, 55 (3), 274-288.
- Stoeger, H., Ziegler, A. in Martzog, P. (2008). Deficits in fine motor skill as an important factor in the identification of gifted underachievers in primary school. *Gifted Education International*, 29(1), 28-42.
- Sudsawad, P., Trombly, C.A., Henderson, A. in Tickle-Degnen, L. (2002). Testing the effect of kinaesthetic training on hand-writing performance in first-grade students. *American Journal of Occupational Therapy*, 56, 26-33.
- Theodorescu, I. in Addy, L. (2007). *Write from the Start 1: Developing Fine-Motor and Perceptual Skills for Effective Handwriting, Book 1*. Cambridge: LDA.
- Theodorescu, I. in Addy, L. (2007). *Write from the Start 1: Developing Fine-Motor and Perceptual Skills for Effective Handwriting, Book 2*. Cambridge: LDA.
- Vinter, A. in Chartrel, E. (2010). Effects of different types of learning on handwriting movements in young children. *Learning and Instruction*, 20, 476-486.
- Wilson, F.R. (1999). *The Hand: How its Use Shapes the Brain, Language, And Human Culture*. New York: Vintage books.